

"Expanding the Human Economy through Off-Planet Resources"

MOON MINERS' MANIFESTO

MMM Classics
The First Ten Years

Year 6: MMM #s 51-60
December 1991 - November 1992

In MMM's 6th year, primary emphasis was put on defining how different city life would be beyond Earth's cradling Biosphere. Cities out there, whether in free space as G.K. O'Neill envisioned, or on the surface of the Moon or other worlds would be radically different. They would have to establish their own mini-biospheres, no longer something to be taken for granted, then learn to sustain them and live within them. This will change everything!

So radical will be the way cities out there will be built and run, that we cannot appropriately use the same word for them as we do for our familiar cities on Earth: whether they be primitive prehistoric towns, third world mega-cities or the affluent cities in prosperous countries. They all get to take the biosphere for granted.

Out there, our settlements will have to reprioritize everything. We need a different word for this different species of urban structure. We call it the Xity: X for "exo-terrestrial, not just beyond Earth, but beyond Biosphere I, Gaia.

We pronounce it not EXity (it's not ex- anything) but KSity, city preceded by a hard K, for the hard hull/shell that contains the manmade biosphere that pioneers now must nourish and care for as if their lives depend on it. *They do!*

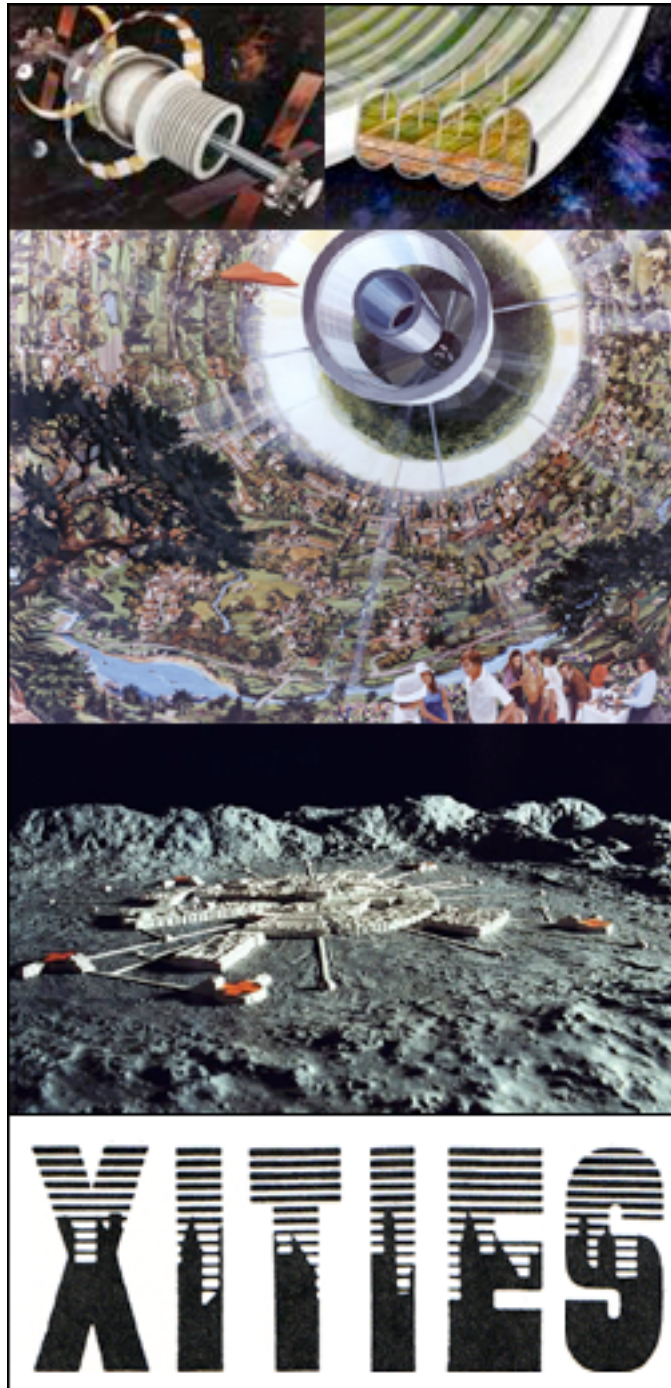

At left: an interior view of the Bernal Sphere Island I space oasis, showing the exterior, top left, and a cutaway of the agricultural rings, top right. Below that is the classic depiction of a lunar surface outpost from the TV Series:Space 1999.

In each issue this year, we take up a different aspect of the Xity and/or how the *new rules* of Xity-building, management, and maintenance will apply in varying situations: on the Moon or Mars, among the asteroids, on Europa, Iapetus, and Oberon in the outer solar system; and in free space itself.

So, in short, while working to define the radical difference between a city as we know it and a xity as we hope to create them, we take the reader on a penny tour of the solar system at large. Our perspective on everything else is transfigured by the insight of the "Xity."

Other topics: of course, we will talk about much more in this issue. Opening space will be a grand adventure with an endless variety of aspects. No matter what your interests, we hope you find some good reads inside.

Fonts: You will notice, that once again we have switched fonts, abandoning the classic Mac screen fonts (Geneva and **Chicago** used in MMMC 5) for Times. Editor's prerogative.

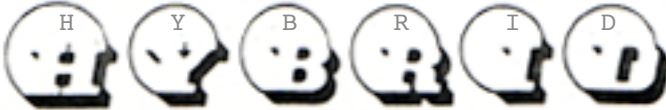

RIGID-INFLATABLE STRUCTURES IN SPACE

By Peter Kokh

In last month's MMM, we explored some possible architectures that could be useful in realizing the frog-hostel concept for lower threshold, timelier, less expensive yet more extensive lunar occupancy. One of the promising avenues looked at was the idea of rigid-inflatable hybrids in which the rigid component was packed with systems modules and the inflatable component providing habitat and activity volume - all in one ready-to-deploy package.

There is no reason why this concept wouldn't work for space structures just as well as for lunar surface outposts. And indeed there have been some precursor ideas. At the 1990 Space Development Conference in Anaheim, California, J.R. Thompson, then deputy NASA Administrator, shared with us some of his surprisingly unfettered thoughts about real near-term possibilities. Thompson felt there was no reason why the Shuttle orbiter, refueled in orbit, couldn't make a non-landing round trip out to the Moon and back. He imagined the payload bay outfitted with a folded inflatable structure. Once in cruise mode, the payload bay doors would open, the inflatable would be filled with air, and the Shuttle would take on a distinctively conestoga-like appearance, reminiscent of a bumper sticker design produced by Peoria L5 some years back.

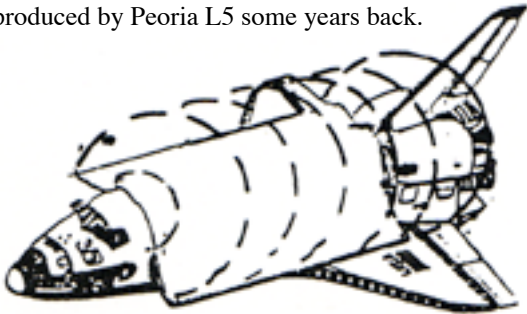

Such an mission could be flown in low Earth orbit, but would be riskier owing to the high concentration of space debris that has accumulated through sloppy, careless, and thoughtless vehicle designs and mission practices. Whether in orbit, or solely on the portion of the circumlunar cruise that lay safely behind the debris zone, such an inflated orbiter mission would be enhanced if the bed of the payload bay were packed with space-lab type modules to structure the use of the volume supplied by the inflatable volume.

To what use could such admittedly temporary volume be put? It could serve as our first "space gym" allowing us to explore the potential of zero-G exercise in a way never before possible. It could allow us to perform physics and processing experiments that required plenty of elbow room. It would be interesting to see how various potential uses would respond to a Request for Proposals.

If we could have a shuttle orbiter hybrid, why not a

shuttle external tank hybrid. The inflatable structure could be stored, along with built-in modules to structure the inflated volume, in the Intertank walls between the liquid oxygen tank on top of the stack, and the liquid hydrogen tank on the bottom. The inflated structure could have the shape of a torus or donut girding the intertank. This could be the main crew habitat area, with the ET fuel tanks used for fuel depot storage or other warehousing.

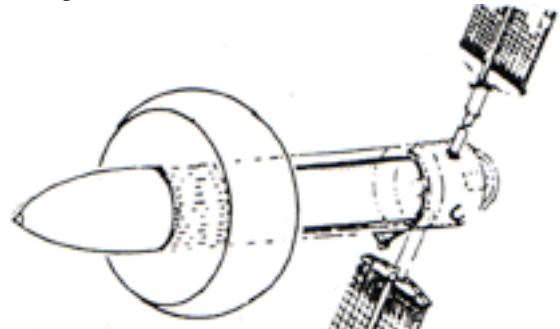

Carrying the shuttle ET with torus crew compartment one step further, if an SSME [space shuttle main engine] cluster pod were attached to the bottom of the stack, refueled our ET with inflated crew collar could become a deep space ranging vehicle making exploratory excursions to Earth-approaching asteroids, for example.

A third space-based hybrid possibility is a payload bay sized space station hab or lab module or a space station connector node module with inflatable component(s) stored in its exterior side walls or end caps. Such hybrid structures could greatly expand the pressurized usable volume of any space station constructed from them. Again, there is the challenge of protecting any inflated component from debris-impact damage.

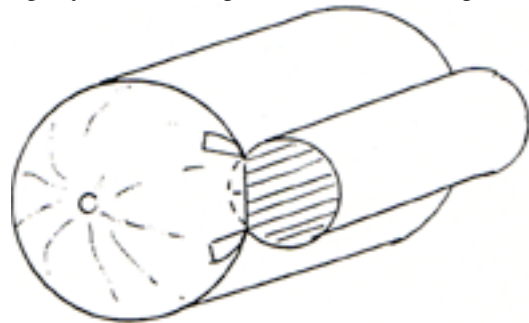

SEND other ideas for space-based or space-plying hybrid structures or for their uses to **MMM**.

"CAMP MILLENNIUM" Design Competition Proposed

To follow up the rigid-inflatable hybrid architectural concepts proposed in our paper on Lunar Hostels and in the piece above, the Lunar Reclamation Society would like to find the up-front money to organize and promote a rigid-inflatable hybrid design competition, in four categories: lunar or Martian outpost in the "donut" category; the same in the "trilobite" category (see MMM # 50 p 7 MMMC #5); and in the space-station and space-vehicle categories. We would also need to secure pledges of incentive prize money (or scholarships to one of the four universities doing architectural studies for NASA). If you can help, or know someone else who might be able to do so, please contact LRS or MMM.

LRS

The two following articles, **EVERFRESH** and **FIRE DEPT**, illustrate just two of the many ways in which *beyond*-the-cradle off-Earth settlements (“Xities”) will be fundamentally different critters from the predecessor Biosphere-I-coddled “cities” that are all we have known until now. As vast as the gap in millennia and technology that separates Çatal Hujuk and today’s developed nation megalopolitan areas, all Earth settlements arise and thrive within a given generous maternal biosphere that they have, till recently, largely taken for granted. There are no other “given” biospheres beyond Earth - at least not within our solar system, and except for global ones that might be engineered in only a few locations (Mars, most notably), each Xity must provide, nourish, and maintain its own. The ramifications of this difference are enormous and pervasive, radically transforming Xities into something cities never were. In future issues, we will investigate Xity urban planning and architectures, unprecedented but essential Xity functions, the logical and almost necessary incorporation within the Xity proper of both ‘suburban’ and agricultural areas, and the quintessential port/harbor character of all future xities. **MEMO**

EVERFRESH

By Peter Kokh

A strange thing happened on the road to energy conservation after the first oil crisis in the late 70s. Totally insensitive to the micro-sources of air pollution and the need for their co-management along with the thermal control which had our full attention, people all over the winter-experiencing world began tightening up their houses. A problem which we never knew we had because it had been effectively neutralized before, suddenly emerged. Both houses themselves and the activities of those within them generate substantial amounts of domestic air pollution. Happily, in our anything-but-tight construction methods of the past, these indoor pollutants along quickly enough dissipated through cracks and openings to the “outside” along with warmth bearing “stale” air to be replaced with cool “fresh” air from the Earth’s generous atmospheric envelope, whose transcendental ambience and carrying capacity we all take for granted.

As we buttoned up our homes and office buildings to conserve heat and reduce the need for heating fuels and/or electricity, we also dammed up a river-flood of indoor air pollutants, a river with many tributaries. Suddenly, for those who had spent good money to make the “improvements”, their indoor air was significantly more polluted than the “outside” air to whose declining quality we had all become sensitized.

Fortunately, there has been an “easy” sweep-it-under-the-rug solution: air exchangers which trade inside air for ‘fresher’ outside air but make a thermal swap in the process. There has been much less attention, unfortunately, to genuine and radical solutions: getting rid of sources of indoor air pollutants in the first place. It is a story of shortsighted economics and simple convenience.

This experience does not set us up well for future life

on the space frontier. Beyond our womb-world, we will not have any all-enveloping placental atmosphere to keep us blissfully cozy. Each settlement will have to contain and conserve its own “atmospherule”. *There will be no “outside fresh air.”* There will only be “inside air”, and in the cases of megastructures like O’Neill cylinder and Stanford torus space colonies or Bova/Rawlings Moon Plaza and LRS’ Prinztown vault-spanned lunar rille-bottom villages, a *very* finite amount of “middoors” air that simply cannot be used as a dump sink.

A “charter-concern” of off-Earth “xities” will be to maintain air freshness within those limited confines. We can’t allow the air to get stale in the first place!

Building materials and furnishing materials that have high outgas flows when new (new car smell, which is nice so long as we can control its intensity by opening the window or vent) will be taboo, to be replaced by those with tolerably low outgas flow rates. Fortunately the offending materials are all organic or synthetic, something that cannot be economically produced on the Moon nor in nearby space settlements dependent early-on largely upon lunar raw materials; and the cost of upporting them out of Earth’s gravity well may continue to be a prohibitive economically-suicidal luxury even if transportation rates fall. Equally happily, the building materials that we can produce on site (metal alloys, cast basalt and ceramics, concrete, glass, fiberglass, and glass composites) are all inorganic materials with significantly lower outgasing.

Synthetics cannot be avoided altogether and for pressurization sealants and lubricants, as much attention will have to be paid to the their outgasing contribution as to the percentage of native (lunar-sourced) content (oxygen, and silicon for carbon substitution). To our knowledge, no work is proceeding along these lines, though undoubtedly, by serendipity, research to date must have uncovered promising avenues for further exploration. But enormous mountains of “filed: no economic use” research data must be “mined” to get at these clues. And space supporters who work in the chemical and petrochemical industry are the ones that have to be motivated to do the necessary detective gumshoe work.

Of late, we have all become aware of a new source of indoor pollution - radon, produced in the Earth’s crust by radioactive decay and working its way up through microcracks, some of it eventually into our basements. Again, in the era of looser homes, this was a problem below the threshold of concern. The potential for radon problems on the Moon are unknown. But the general rate of radon seepage is one of the things that ought to be weighed in the process of base or settlement site selection. But perhaps we ought not to be overly worried as the both the relative extreme over-pressurization of lunar habitat space (in contrast to lunar vacuum) and the attention to sealants and leak detection that will be in force to maintain and contain pressurization (the expense of replacing leaked atmospheric nitrogen, exotic to the Moon, being the 2x4 poised to strike between our eyes) will work to force crustal radon to find other avenues of escape.

Then there are the pollutants that come from life activities: housekeeping, food storage, cooking, laundry, and personal hygiene. In the lunar or space settlement kitchen, the

need to minimize rather than dissipate odors, the need to minimize aerosol oils production (if you've ever lived with anyone whose culinary skills are limited to frying, you know only too well what a problem this can be), and the attendant humidity control problems poised by steam will all force major changes in the way pioneers prepare food. Frying will be a no-no as will, of course, be barbecuing.

Open boiling will also be taboo. Even the oven will be frowned upon. But that does not leave us with a diet of uncooked and/or cold foods, though the proportion of these will probably strike a healthier balance. There remains the friendly food-zapper, *provided* the concerns of some about micro-wave emission dangers prove unfounded. But, when taste and flavor are more important than convenience, there is an old standby waiting in the wings, now largely in disuse except by a dying generation of grandmothers: the old-fashioned pressure-cooker, tops for speed, flavor, texture, and odor and steam control.

A word about barbecuing. While domestic BBQs may be taboo (there being no "outside" porch or patio but only tightly controlled and policed "middoor" ones) specially licensed restaurants *with their own separate and expensively recycled atmospherules* may offer char-broiled steaks, ribs, and chicken - if the meat can be found for an affordable price!. Eating there will be much more expensive than dining in the most expensive five star French restaurants here on Earth.

A companion problem, not to be treated lightly, is storage of food. On Earth, we consider that if someone doesn't mind accumulating preserves of spoiled produce, meat, and leftovers in their pantry, cellar, or refrigerator, or pay attention to the control of in-house food waste composting systems, that is their problem. In the closely shared finite air supplies of off-Earth settlements, it will be everyone's problem. The low priority now given to education on good housekeeping practices will need to be drastically altered. The same goes for accumulations of unwashed soiled clothing.

Bathroom odors are a separate problem, one which we treated in our article "Composting Toilets" ["Compostlets"] in MMM # 40 p5 NOV '90. But for these and cooking odors that can't easily be reduced below a stubborn minimum, a system of stale air 'sewer' and 'drainage' ducts from key localized areas and eventually exhausting into agricultural areas for natural refreshing, will constitute a unique new xity utility service.

The problem of humidity-control we have already mentioned. In the limited shared atmospherule, plant transpiration alone will produce excess humidity, a potentially severe source of mold and mildew. Dehumidifiers will be the logical source of the fresh water supply, organically dirty but chemically clean used water being used for irrigation in a natural cycle. Priority attention will have to be given to dehumidifier housekeeping to avoid such things as potentially community-wide outbreaks of Legionnaire's Disease.

Next in concern are household cleaning and surface maintenance agents. Many of those in common use on Earth are far too aromatic and far too productive of air pollutant aerosols to be approved for space frontier use, domestic or

commercial. In some cases, a light adjustment of formulation may remove the offending characteristics. In other cases brand new or discarded old substitutes will need to be found, or rediscovered. Happily, the challenge posed by today's tightened homes will gradually promote the appearance of acceptable alternatives by marketplace economics.

Now we get personal. *Even outdoors*, we've all on occasion encountered the person who has either chosen to mask the odors of neglected personal hygiene, or compensate for a self-image of sexual inadequacy, by using enough perfume or cologne to make a French harlot seem puritanical, notifying all within fifty feet of his or her approach, even in a stiff wind. On the space frontier, aromatic intensity of available cosmetic preparations will be tightly controlled, and almost all those currently available on Earth will be contra-band. A stress of personal hygiene and attention to more subtle ways of personal image building will have to substitute.

And smoking? Without a profligately generous atmospheric fresh air sink all about, public smoking will be totally taboo, and private smoking allowed only in spaces, home or private club, *expensively* provided with quarantined separate air recycling systems.

We've all met people with green thumbs, whose homes or apartments are a delightful jungle of live greenery. While most everyone likes a few house plants about, what would commonly be seen as "overdoing it" will be the standard in lunar and space colony homes, a cultural norm that doubles as a natural psychological defense response to settler awareness *ever just* below the attention threshold, of the stark barrenness and sterility of the absolute ultimate desert from which they are separated by the settlement's pressurization containment. It will be a norm carefully fostered by deliberate education. House plants aid in keeping the inside air fresh both by recycling exhaled carbon dioxide and by filtering out airborne pollutants, some plants doing a better job of this than others.

The challenge of mini-biosphere maintenance begins at home, inside. For on the frontier, "outside" is only vacuum. It is one thing that will characterize *xity* life as drastically different from Earth-normal *city* life with its *laissez-faire* attitudes and happy-go-lucky lack of concern. MMMM



by Peter Kokh

Fire and Man go back a long time together. A natural phenomenon frequently caused by lightning striking tinder dry forest, brush, and grassland, our ancestral domestication of fire for cooking, heating, artcraft and manufacturing purposes played a role in the rise of civilization hard to exaggerate.

Yet fire out of hand or out of place has been one of the most devastating and frightening perils to life, limb, and property. Our response to this danger has been one of fire

codes attempting to both minimize the chance of accidental fires and control the spread of fires once begun. Most every community is served by a paid or volunteer standby Fire Department. In most cases, unwanted fires are quickly controlled and potential damage limited. Smoke and other volatile combustion by-products of fire are quickly dissipated by flushing to the circulating winds of the vast atmospheric sink surrounding us.

Alas in settlements beyond Earth's atmosphere, the volumes of air available to absorb fire gasses, smoke, and other particulate by-products will always be most severely limited in comparison to Earthside. Instead of an atmosphere miles deep above our abodes and over vast thinly populated rural areas, we are likely to have only the few cubic meters per person within pressurized habitat, food growing and work areas and other common places. Even in relatively voluminous megastructures like O'Neill colonies or the Prinztown rille-bottom double vault span design, the available "middoors" common volume will still be so minimal by Earth standards that we will have to forgo a strategy of merely controlling fire.

Having nowhere to flush the smoke and fumes, a settlement that has even a small, quickly controlled fire may face at least temporary wholesale abandonment, the incident a catastrophe out of proportion with previous human experience.

Instead, settlers will have no choice but to adopt a *zero tolerance* for fire. Their first line of defense will not be an automatic fire suppression system, no matter how elaborate. That can only provide a damage control backup and a futile one at that, simply buying time needed for orderly evacuation to standby vehicles or shelters. Rather spacefolk must accept settlement design strictures all but guaranteeing that fires can't start by accident, and that set fires have nowhere to spread.

Because most combustible materials are organics or synthetics rich in carbon and hydrogen, two elements scarce and exotic on the Moon, lunar towns and early space settlements built principally from lunar materials prior to the eventual accessing of cheap volatile sources elsewhere (Phobos and Deimos, asteroids and dead comet hulks) sheer economics will force the choice of largely inorganic and incombustible building materials, furniture, and furnishings. Commonplace wood, paper, organic and synthetic fabrics, and plastics will become exorbitantly expensive choices reserved for the obscene consumption patterns of the ultra-rich. In their place will be various metal alloys, ceramics, concrete, glass, fiberglass, and fiberglass-glass composites (Glax™). Even electrical wire will, for economic reasons, be manufactured on site with inorganic sheathing in place of commonplace plastics. Frontier houses and other structures *simply will not burn*.

On the Moon, the low gravity ("sixthweight") will greatly reduce the need for cushions, pads, and mattresses that cannot be easily made of these available incombustible inorganic materials. Early Space Colonies will thus have a second incentive to choose lunar standard gravity rather than Earth normal (the first reason being to allow much tighter radiuses, greatly reducing minimum size and structural mass, significantly lowering the threshold for construction).

The two areas of greatest remaining concern will be

clothing and drying or composting agricultural biomass. Cotton, since its lunar sourceable oxygen content is much higher than any that of any other fiber choice, renders it easily the least expensive selection. The need to recycle its carbon and hydrogen content upon discard of items made from it, will mandate processing choices for cotton that are organic and thus happily preclude additives with toxic combustion products. The best strategy may be to isolate (even in fabric and clothing shops) concentrations of cotton fabrics and garments from one another in relatively small caches, each guarded by a sprinkler.

Biowaste and biomass management and housekeeping practices, combining strict personnel training with discontinuous storage in small concentrations below critical mass (but again with one-on-one sprinkler vigilance) should all but banish chances of spontaneous combustion and make the spread of set fires impossible. Special attention must be given to grain and powder storage housekeeping and management.

IN SUM: on the early space frontier, fire "control" departments will provide no security. If a fire big enough does break out, the game would be already lost. But what if, despite all precautions, the unthinkable does occur?

Fire shelters connected to the community by air-tight fire doors and relative overpressurization could be provided, doubling as shelter in event of pressurization loss. However such shelters must be large enough to accommodate the entire community on a short term basis. It may be prudent to design the community with enough fully "isolatable" storage and warehousing space or agricultural space to serve emergency needs. For the only way to recover from a fire may be to depressurize, then repressurize the affected area. Since a fire may well leave no option but retreat, there should be periodic en masse orderly evacuation drills for the community at large.

As the constraints on building materials ease through cheaper out-sourcing from Deimos and Phobos and/or asteroids and comets, the taboo on using organic and combustible synthetic materials for in-settlement structures, furniture, and furnishings must not be relaxed. In most space locales we will never have the luxury of enough contained ambient atmosphere to allow a return to our current flush it and forget it strategy.

On Mars, in contrast, thanks to the thin carbon dioxide atmosphere and available water and ice reserves, pioneers should be able to produce inexpensive wood and plastics with almost Earth-like ease. Yet here too, until the far off dawning of some new age of "terraforming" that installs a planet-enveloping commonwealth of breathable air, human settlements on Mars will labor under the same threat of sheer disaster from even the most minor of fires as will lunar and space settlements. If the Mars settlements are to allow wood and synthetics, it will be wise they do so with constraints that work to isolate them in discontinuous small pockets.

Economics on Earth has made the abandonment of combustible materials unthinkable. Instead, fire is tolerated and we have "Fire Departments" for "control". Beyond Earth, quite different economic realities will combine with a major exacerbation of the threat posed by fire to make fire truly intolerable, and a strategy of control futile. There won't be any Fire Departments in space frontier towns. EMMA



The Role of the Campfire

Many things have worked to humanize and civilize our ascending species over the ages. Surely one of the earliest, and one which to this day continues to act as a social catalyst, is the campfire, the fireside,



the hearth. Around the fire stories are told, songs sung, and myths and legends passed on. Many a science fiction yarn has its characters plotting by the warmth of a fire on some star-sunned planet - one with breathable air, of course. But elsewhere in our own Solar System, fire's mystic magic may be denied us, unless => FIRESIDE, below.

XITIES

Series Cont.
Pronounced
KSIH-tees'
not EX-i-tees

Beyond-the-cradle off-Earth settlements ("Xities") will be fundamentally different from the familiar Biosphere-"I"-coddled "cities" that have arisen over the ages to thrive within the given generous maternal biosphere that we have largely taken for granted. Elsewhere within our solar system, each xity must provide, nourish, and maintain a biosphere of its own. Together with their mutual physical isolation by surrounding vacuum or unbreathable planetary atmospheres, this central fact has radical ramifications that must immediately transform space frontier xities into something cities never were.

In this issue, we investigate a gamut of essential xity functions, some familiar but strongly redefined, others new and without precedent, and their demands upon the structure of xity bureaucracies, government, and politics.



Xititech

By Peter Kokh

While heretofore in human history many departments of cities and towns (health, light and power, streets, traffic, parks, schools etc.) have at least some number of professionals with germane expertise on their payroll, the policy distorting interference of elected politicians, patronage appointees, and job-secure civil servants more often than not has the upper hand. No matter how poorly citizen needs are met, no matter how "unlivable" in relative terms urban areas may become, people survive. Gaia, the Earth's mothering biosphere, even in the extremes of its climatic crescendos and geological catharses, is relatively friendly even to the shelterless.

Whatever may be the case some distant day out among the stars, anywhere else in our Solar System hinterland that we might eventually establish pockets of civilization, the hostile host environment will not be so forgiving of task-bungling in the name of self-serving interests. Unlike cities,

"xities" must be run largely by professionals and technicians if they are to remain "livable" in a sense that is starkly absolute.

To illustrate, consider the department structure likely to be found in any xity government. But lets go backwards in order of significance to our thesis, that is in order of most familiarity to present day terrestrial urban area experience.

Xity SCHOOL Systems

In this country at least, we have an enormous tolerance for mediocrity and outright failure in our schools. After all, our society (as distinguished from the Japanese, for example) is one of atomic individuals whom we deem responsible for their own success or failure. "God helps those who help themselves" etc. We put a low priority on bettering the odds individuals must face. As a result, we are inexorably becoming a second class nation by all per capita (as opposed to gross) standards of measurement. But we will survive.

On the Moon, Mars, out among the asteroids, or in space colonies in free space, clusters of humanity will be so much more challenged by both high thresholds of economic viability and the fragile vulnerability of all but "sink-less" mini-biospheres. They cannot hope to long survive unless they collectively see to it that their xitzenry is appropriately educated on all points on which their continued existence tightly clings. With one on one attention if need be, they must be prepared to accept a much higher level of individual and actively cooperative responsibility for their "commons" [whatever cannot be privately owned like the air, waters, and the environment in general and for which no one therefore seems individually accountable or responsible].

Along with other subjects, each must learn well the facts of mini-biosphere life and the workings of biosphere support systems in enough detail to appropriately affect their individual micro-economic decisions as well as their environment-relevant housekeeping habits both public and domestic. Useful in building appreciation and respect for the xity's potential failure modes would be a universal service system in which each student would at some time do yeoman stints on the farms, in air and water freshening and biowaste composting utilities, in discard collection and recycling chores, and on pressure-integrity maintenance crews. Because their existence will be far more critically dependent on technology than even our own, they cannot possibly be either good enough xitizens or enlightened voters if the rudiments of science and technology are treated as electives as is common practice Earthside. [See "the 4th R", MMM # 34 APR '90., MMMC #4]

Such education will be most effective, of course, if appropriate incentives and conveniences to proper action are built into xity systems. We are too used to passing ordinances without thought to making compliance easy and natural, if not second nature. (If you outlaw spitting on the sidewalk, you should provide handy spittoons, etc.) That will have to change if xities are to succeed against the enormous odds. Living downwind and downstream of themselves, xity-dwellers will be especially prone to choking fatally, en masse, on the business-as-normal normal by-products of daily life.

Baring censorship, a poor solution, space frontier xitizens, settler and native-born alike, will likely be reminded or exposed to the saturation point with television and videos

depicting everyday life in Earth cities under conditions so relatively forgiving as to permit general inattention, dismissal, or even contempt for the commons. In frontier xities, schools will have to sweat up an especially steep hill as a result.

Future Lunans, Martians, Belters, or Space Colonists may not be able to order the latest fashion design, kitchen convenience, or electronic gizmo from the Sears catalog, or go to their neighborhood K-Mart or area mall lined with specialty shops featuring everything under the sun. They may not have supermarkets with an infinite selection of prepared convenience foods, toy outlets featuring plastic incarnations of the latest cartoon heroes, bad guys, and monsters. Nor will the current fare in chic throwaway fascinations Earthside be available.

Instead young and old alike will have to be prepared for the crude, make-do substitutions of the frontier. This will strongly motivate settler artists, craftsfolk, and entrepreneurs to make and produce improved and refined goods that from production to ultimate disposal respect their fragile mini-biospheres and the recycling systems that help make them work. At the same time such new wares will help build a do-or-die long-term trade surplus (see below) by ever working to further defray "upports" from Earth and expand total exports.

One can imagine the curator of the local museum selecting for the "Reminiscences of Earth" hall, principally ethnic folk and frontier items that, even if not appropriate for space frontier situations, demonstrate encouragingly the best in human resourcefulness under challenge. By contrast, the latest carefree titillations for individual convenience will be well enough represented by film and video.

Xity HEALTH Department

Space frontier Health Departments will be charged with more aggressive attention to public and domestic house-keeping conditions that could promote the spread of any pests that slip through space transportation safeguards (food cargoes pressurized in 150° F nitrogen, or exposed to vacuum; settler screening and clothing trade-ins etc.) But here again, education will be primary.

Public **health dollars** in the U.S. grease the squeaky wheel. Thus much more attention is given to keeping the no-longer productive person alive, than in ensuring that the young do not grow up so unhealthy as to later burden the system. Space frontier settlements will be hard pressed to survive unless a much higher fraction of their populations are productive than seems acceptable on Earth. So priorities will be turned around with emphasis on expectant mothers, infants, children, and seniors with good years left in them. In respect to the latter, the emphasis must be on improving quality of life, not on extending it for extension's sake. Bear in mind that in very isolated space frontier settlements, xities may be really xity-states, concerning themselves locally with cares here left to the state or jockeying candidates for national office.

Development of all-new Sports will be a new concern for xities, or for associations of xities sharing similar gravity/inertial situations. For most of the traditional sports we now enjoy will transplant poorly. [Jai Alai is one possible exception]. But Earth-return physical and physiological rehabilitation programs might well be left to free enterprise.

Department of SOCIAL Services

For reasons already cited, when it comes to Social Welfare, the xity's "first line of defense" must be before-the-fact prevention rather than after-the-fact assistance or outright neglect (not only in third world cities, but of our own urban address-less). The universal if never stated presumption on Earth that, if need be, people can survive fending and foraging for themselves, will be an all too obviously unthinkable one within the confines of mini-biospheres quarantined from one another not only by miles, but by hard vacuum and radiation or unbreathable planetary atmospheres. Again the stress will be on education and training to be *flexibly* productive.

Department of ECONOMIC Diversity and Trade

Nowadays, increasingly strapped American cities are taking a much less laissez-faire attitude towards their industrial and commercial bases. For xities, this will not only be a way of countering economic decline as they age, or to promote new and refound prosperity, but a matter of sheer survival. In point of fact for Earthbound cities, as the nations they drive, a negative trade balance with the outside can be sustained for a surprisingly long time - though tolerated slippage in the standard of living, and/or reversion to "simpler times" - read more direct reliance on the support capacity of "Mother Earth". And through income redistribution bandages, areas that lag badly can be propped up by those enjoying better times.

Neither recourse is likely beyond Earth-orbit. Xities will either ever re-justify themselves economically, or they will end up being abandoned, sooner rather than later. Xities, and associations of xities sharing the same planetary or space setting, must through publicly supported means, endeavor to ensure that local entrepreneurs find ever new ways to turn local resources (or other raw materials more cheaply accessed than shipment up the expensively deep gravity well from Earth) into new products for domestic consumption to reduce the need or pressure to upport from Earth, or into products for sale to Earth, Earth-orbit facilities, and to other off-planet settlements, in sufficient volume to fully pay for whatever upports and other imports that the xity cannot (or prefers not) to do without - and to do so with reserve-building surplus.

A **xity university**, however modest by today's standards, would be a logical agency to promote industrial and commercial diversification, even helpful new arts and crafts. The university could do ground-breaking materials use research and then assist entrepreneurs in development of marketable products for some limited share in the royalties.

To support this diversification, xities on planetary surfaces (Moon, Mars, larger asteroids, etc.) will support continuing development of the potential economic geography of their hinterland surroundings. This will mean establishing satellite outposts (some of them perhaps to become rivaling xities in their own right) in order to add to the mix of minerals and raw materials upon which economic diversity rests.

Space Colonies, each more like Singapore than analogs of giant Japan (a comparison frequently made), may bind together in leagues to better exploit asteroidal and cometary resources. The goal will be to lessen the restriction of their economies to industries supportable by a diet of lunar raw materials alone. This need to establish and continue a favorable

trade balance will drive an initial handful of surface and space xities ultimately to develop much of the Solar System, whether Earth itself remains interested or not.

An **Office of Strategic Materials and Import Protocols** could employ some blend of taxation and credits to ensure that strategic materials in short supply (e.g. on the Moon: hydrogen, carbon, nitrogen, and metals other than iron, aluminum, titanium, and magnesium) were not diverted into spurious luxury uses or tied up in non-durable products without efficient fast-turnaround recycling systems that work.

It will be also be in the xity's interest to maximize **interxity trade** so that together the xities are not just financially *self-supporting* but also industrially and agriculturally *self-sufficient* if ever Earth cuts off trade, whether as a result of world conflict, major depression, isolationist politics, or the spreading of hostile fundamentalisms in the various world faiths. Such an ability to collectively survive the cutting of the umbilical cord to the womb-world must be the cornerstone of every xity-state's "foreign" policy.

Department of the Xity BIOSPHERE

The differences between *mega*-biosphere-contained cities and *mini*-biosphere-containing xities, as described above, while significant, may seem matters of stress, emphasis, and priority. We won't argue the point. But that's as far as one can stretch the kinship. No city on Earth must build a containment system, mega-structural or modular, for its atmosphere. Nor need any city on Earth concern itself with maintaining its own climate or the routine sequencing of its seasons (beyond the provision of air-conditioned skywalks and other structure-connecting passages, as popular perks).

No city on Earth must be dependent upon a *closed* loop water supply, drainage, and recycling system totally within its own limits (even island city-states like Singapore have the surrounding sea). In contrast, no xity will ever be founded on a coast or lakeshore or river or over a subsurface aquifer - at least not until the "rejuvenaissance" [a coinage decidedly preferable in its connotations and the pathways it suggests to "terraforming"] of Mars is fairly well along.

A **Corps of Pressurization Engineers** will be charged with containment integrity and maintenance of the atmospheric pressure of the settlement within the desired limits. Ever vigilant for leaks and structural weaknesses, they will preventively repair microcracks, monitor the performance of sealants, and relieve structural stresses safely. Automatic detection devices and frequent human inspections will be crosschecks in preventing failures of regular airlocks, liquid airlocks [MMM # 17 JUL '88], and matchports [MMM # 15 MAY '87 - both included in MMMC2]. The corps' job will be different in megastructures such as O'Neill colonies, Bova-Rawlings' Main Plaza [Welcome to Moonbase, Ben Bova, Ballantine '88] or the double vaulted rille-bottom villages of the Prinztion design (LRS '89) from that of those charged with this most critical of all xity responsibilities in modularly constructed settlements with physical growth potential (banded and modular torus space colonies, the double helix oases [MMM # 11 FEB '88], and any of the more common Moon and Mars base proposals. Depending on the settlement's overall architectural plan, separated or separable fall-back safe

havens need to be provided and maintained.

The work of the corps presupposed, the **Office of Atmosphere Quality** will be charged with maintaining air freshness and the proper mix of gasses: oxygen, nitrogen or other buffer gasses, and carbon dioxide.

The settlement may have some sort of baffling separating the agricultural, residential, and industrial areas. If so, the fans and ducts which provide for flow of fresh and stale air across these baffles without back flow, need to be maintained to preserve air quality.

The **Hydrosphere Office** will maintain the xity's water reserves and their cycling starting with the dehumidifiers that condense excess humidity from plant transpiration to provide fresh clean drinking water. The Office may maintain a tritreme drainage system [MMM # 40 NOV '90 "Cloacal vs. Tritreme Plumbing"] that keeps separate, for ease of treatment, sanitary waste water, gray water from washing and bathing, agricultural runoff, etc.

On the Moon, reserve water supplies may be shunted in a cycle through dayspan electrolyzers and nightspan fuel cells to produce power to complement off-line solar generators. Reserve water can even be cycled through closed-loop high head rille-side or crater-side hydroelectric stations, again to boost nightspan power [see MMM # 31 DEC '90 pp 4-5; also in MMMC #4].

But reserves can also be used to improve air quality by running them through fountains and waterfalls to mist and cleanse the air, and to add further to the quality of xity life in the form of canals and lagoons for boating, pools for swimming, and even trout steams for fishing.

Whereas some cities take upon themselves the task of providing and maintaining green markets by which produce from rural farms can be sold directly to city dwellers, in xities beyond Earth, under the Biosphere Dept., there will be a **Sub Department of Agriculture**, with far more responsibility than even national agriculture departments here on Earth. For in xities, the antithesis of farm and city will be resolved. The xity will contain major agricultural areas within its biosphere, not only for logistic and economic sense, but because the farm areas will play the critical role in the recycling of stale air into fresh. The composting of solid organic wastes will be its duty.

A system of parks, pathways, picnic strips and memorial gardens might well be integrated into portions of the agricultural areas adjacent to residential, industrial, and commercial zones. Since the emphasis will be on plants that serve an economic need, even landscaping and "streetside" plantings will be selected to fulfill a dual purpose. Thus the whole eco-system makeup of the xity biosphere's general flora will be under this sub-department.

Agriculture will also bear upon the selection of live-stock (*if* meat-eating survives as an accepted lifestyle) and the xity's complement of urban "wildlife" (some species needed to make the eco-system work, and maybe some others more for public enjoyment). This sub-department would also license allowable pets and enforce their reproductive control.

As serious a job as is running a major city in today's world, the burden of responsibility on the Xity Parents out on the space frontier will be much heavier. The very continued

existence of the xitizenry will lie in their hands. There will be far less room for the discretionary nonsenses of political decisions, far more entrusted to the care of responsible technicians. This will affect not only the structure and divisions of xity bureaucracy but the roles of elected officials and how they see them.

These life-in-the-balance responsibilities may even require final abandonment of the dictatorship of the majority [our present system, wherein each faction attempts to gain a mere 50% plus advantage, in order to thrust some premature solution serving vested interests down the throat of any other equally non-cooperative faction] for governance by informed consensus. Government by co-“promise” not by compromise.

The extra-terrestrial xity will be a precedent shattering institution. And just maybe, Earth cities will pick up a few helpful pointers in the watching. 

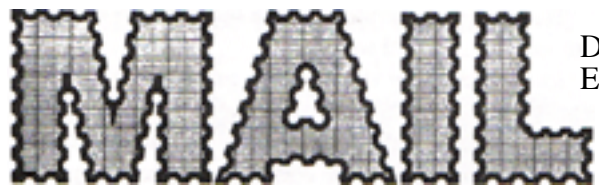

Dear Editor

[TO OUR READERS: We appreciate your letters. We can't print all of them, but we will try to pick those which shed interesting new light on things discussed in MMM.]

29¢ # 1) MMM's layout and design

I notice less use of the fancy letters for titles (like TREES and HOSTELS in # 50), and I think that that's a move in the right direction. They look, well 70ish. Out of date. I'd drop them. Maybe get some shadow, or 3D letters, more modern, hip, cool, groovy, whatever.

Andy Weber

Walnut Creek, California

[EDITOR's reply: I started using such art titles taken from a number of print books on graphic fonts, with the very first issues of MMM because, lacking an ability to illustrate my own articles and finding no volunteers to do it for me, they gave me a way to graphically set the atmosphere, suggesting in some fun way the topic under consideration. To an old fart like me, 70ish *is* modern! It comes down to this. Whether you like them or not doesn't matter. *I like them. I am a volunteer.* And the day I am not allowed to have fun with my own creation is the day I take my football and go home. But as you say, I did ask for comments.

[snip]

More white space may be graphically desirable in an ideal world, but *either* means less content in a fixed number of pages, or more pages - at greater printing cost. Given that choice, I'll sacrifice appearance for content any day, at least until we find some sweetheart to print MMM for free!

Sorry you are too busy to create more HARVEST MOON cartoons at the present time, [see MMM Classics 4 and 5] but I understand. *Many thanks* once again for those you have sent us in the past. - PK]

On the Space Frontier, can there be any

FIRE SIDE

around which to gather?

By Peter Kokh

Since time immemorial, ever since the taming of fire, humans have sought warmth, comfort, and company huddled around campfires and hearths. Even today, when a dwindling number of modern homes boast the luxury of a fireplace, nestling around the fire is something we all enjoy - when it is cold or damp, when we are out camping, on a clambake or a picnic in the park, or just out on the patio or in the back yard for a barbecue or marshmallow roast. And can any of us forget the bonfires after a high school homecoming football games?

While nowadays, such pleasures are scarcely everyday experiences, however infrequently enjoyed, the magic of the fire is so much a universally positive experience that it is still possible to ask: “can it be humanity if there is no campfire?”

In “FIRE DEPT.” MMM # 51 DEC '91, we pointed out the very intolerability of open fire, controlled or not, in the very limited atmospherules of mini biospheres. But that is not the last gloomy word, for it only applies to fires in which the combustion products are smoke and toxic gasses.

In MMM # 40 NOV '90 “METHANE” we discussed the possibility of controlled burning of compost-pile derived methane to produce water vapor along with CO₂ for plant nourishment. Such combustion will need to be confined to nitrogen-free chambers so as to avoid unwanted nitrogen oxide byproducts. Could such a methane-oxygen fed flame in a glass-faced chamber serve as a fireplace substitute? Why not?

It should also be possible to devise a tightly confined hearth “substitute” that slowly fed together pure hydrogen and oxygen. If again the burning is confined to a nitrogen-free chamber, the only combustion product would be steam - pure water, which can then be used for drinking or other purposes. In effect, we are talking about a modified fuel cell, in which the 2H₂ + O₂ = 2H₂O reaction is run somewhat faster, not so fast as to be explosive, but fast enough to sustain a flame, perhaps with a harmless enough additive (if one can be found!) to colorize the normally invisible H+O fire.

I'd be surprised if either such device now exists, with little market for them - down here. But out on the frontier, a flame-in-a-jar device might create enough symbolic warmth and cheer to become commonplace in settler homes on the Moon or Mars or elsewhere, in gathering spot lounges, even on long trips aboard spacecraft or surface roving coaches.

Why not tinker up such devices now? The methane version could not be used in draft-tight close quarters but a hydrogen hearth might sell to apartment dwellers, especially singles wanting the latest in trendy mood-setting gizmos. Just knowing that we could take such “**fire chamber**” with us, could make the prospects of life on the space frontier just a little less daunting, just a little more reassuring. 

XITIES

Series Cont.
Pronounced
KSIH-tees'
not EX-i-tees
Part III

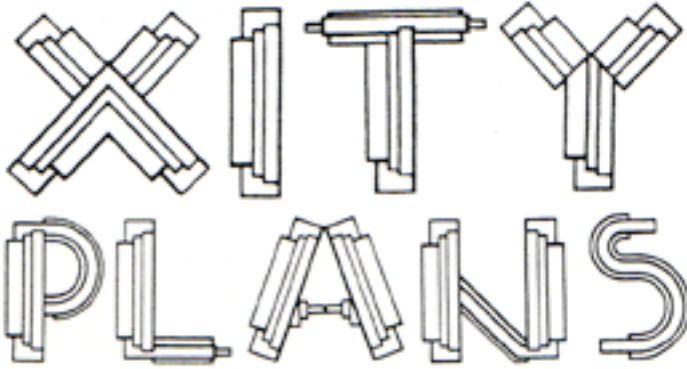

By Peter Kokh

INTRODUCTORY DISCUSSION

As a rule proved by its exceedingly rare exceptions, Earthbound cities are founded and grow haphazardly, a mosaic of micro-economic decisions and ad hoc solutions. Sometimes there are scattered allusions to a priori blueprints showing up in road systems and other infrastructures. But far more often, and especially the case with older cities, there is no more than some brave flirtation with after-the-fact master planning that attempts to rescue order from chaos and impose some facade of logic. All of this development occurs within the context of the transcendent terrestrial biosphere, without which such "wild" growth and development patterns could not be suffered.

Xity as Biosphere

Beyond Earth, the tables are turned, and biospheres will exist solely within the context of discrete xities. That makes xity planning serious a priori stuff with more, or less, room for subsequent adjustments. First, considering the xity's design as a biosphere provider and maintainer, the challenge is far greater than almost all space development advocates and visionaries imagine. Most artistic visualizations of lunar or Martian surface settlements that one sees (and they determine the expectations of those who cannot visualize on their own) show a maze of habitat and function modules with token inclusion of agricultural areas. That won't do. Consider a trial definition of a xity:

A XITY is a human outpost outside Biosphere "I" (Earth) that (1) provides not just permanent serial occupancy, but permanent lifetime residency for individuals and families, and their educational, cultural, and other needs; AND (2) provides as complete a bioregenerative life support system as is practical.

As ongoing experience with the Biosphere II project, in its fourth month of closure at this writing, is demonstrating

so well, even a much higher ratio of plant mass to human mass than most space planners had naively thought they could get by with, is proving inadequate. CO₂ scrubbers have had to be installed.

Xity master plans can not simply place plant life and food growing areas in a human context. They must sprinkle humans sparingly, as they are the more dependent partner in a fragile symbiosis, in a setting that is principally one of vegetation and crops.

In other words the xity must include its own rural hinterland. Without this, there is no hope of providing any real sort of biological flywheel, leaving settler survival to depend proportionately on machines, however sophisticated, with their much higher susceptibility to "failure modes".

Xity as "individual-friendly"

There is another challenge here. As individuals, we give significance to our lives as we make over into something friendly and personal what greets us as strange and impersonal.

To the extent Xities need more careful and more closely followed master planning than cities, can they provide shelter without suffocating individual need to creatively design it-says-me personal space?

It is not enough to provide for interior decorating opportunities. It is equally vital that the public appearance of private spaces be left to resident discretion.

Indeed, it is often the very unplanned character of Earth's cities, the colorful patchwork patterns of individually determined "improvements" through the years and generations that, however it sometimes threatens over all functioning, can make them such delightful places to live in. Master plans which do not leave maximum play for individual discretion, as many a well-intentioned urban renewal project has attested, can choke the very spirit out of a city and its individual residents, even while attempting to unchoke urban traffic and provide an overall alluringly deceptive tyrannical beauty.

BASIC OPTIONS

[While as an unapologetic "planetary chauvinist", the writer's chief interest lies with settlements on planetary surfaces, the general points made here *must* be applied *as* religiously by xity-architects of space colony settlements as well. For a fresh new approach to the latter, see MMM # 12 FEB '88 pp.3-7 "SPACE OASES: Part 4. Static Design Traps, and Part 5.A Biodynamic Masterplan". For the complete 12 page series on Space Oases see MMM Classics #2.]

I. "Thesis": UNITARY Megastructure

Eye-catching visionary depictions of free space and planetary surface settlements involve great megastructures that must usually be completed in toto before the first settler can move in. They must sooner, rather than later, reach the design limit for their population with ensuing cultural stagnation and ecosystem aging being the common prospect.

PLUSES: √ megastructures offer less surface per volume (even per square foot) with correspondingly fewer joints and couplings able to spring pressure leaks. √ As conceived, they offer greater space for a life-supporting ecosystem - at least until the pressures of growing population in a fixed

volume results in the temptation to “develop” “natural” areas. ✓ The large open volumes of such megastructures also offer easier air circulation pattern promising simpler maintenance and lower atmospheric failure modes.

MINUSES are ✓ the very high occupancy threshold - a lot of construction before the first citizen can move in; and ✓ the lack of easy congruous growth potential. ✓ The temptation to erode an initially good biomass-population ratio by encroachment has already been mentioned.

Megastructures share structural failure risks rather than distribute them locally. Further, such structures also have the greatest need for extra counter-pressure structural reinforcement. A plus and minus both, Lunar and Martian megastructure xities will need extra shielding to gravitationally counter the structure-straining air pressures within, increasing the desirability of less than Earth-normal atmospheric pressure, already attractive as a nitrogen import cost cutter.

Familiar examples of such Megastructure Xities in free space include [NOT TO SCALE] the [1] Stanford Torus, [2] the Bernal Sphere, and [3] the O’Neill Sunflower cylinder.

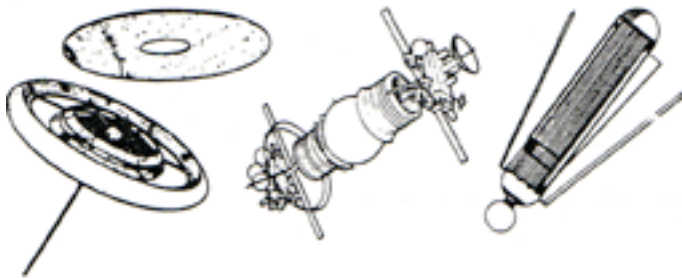

Surface examples of the megastructure approach are the Bova (Rawlings illustrated) “Main Plaza” and Domed Xity.

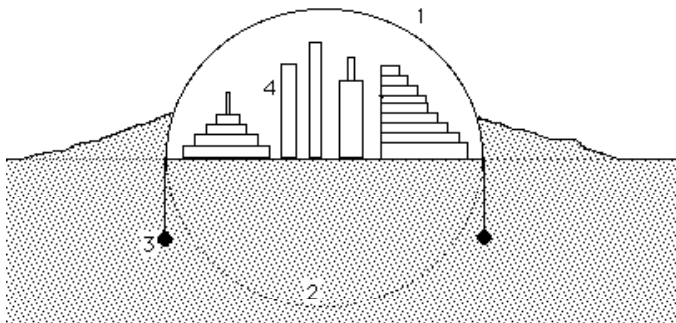
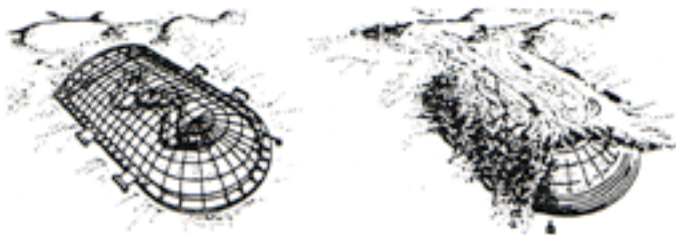

THE DOME - favorite of Sci-Fi pulp covers. A glass? hemisphere or geodesic dome [1] (which, unlike a full sphere or cylindroid [2], must be anchored [3] to prevent it from being blown off the surface by internal air pressure) allows traditional Earth-style architecture (e.g. skyscrapers [4]) to be erected within. While glass can protect against ultra-violet, unless 2-4 meters thick, it could not protect against cosmic radiation or solar flares. If the glass is thinner than that, the exterior walls and roofs of the enclosed buildings would have to be thick enough to serve as shielding, and inhabitants would have to severely limit their excursions “outdoors” within the dome (i.e.

middoors). A domed xity may be a bit less far-fetched on Mars than on the Moon especially *if* the native CO2 atmosphere can be thickened appreciably.

II. “Antithesis”: MODULAR Versatility

Most recent design studies for space frontier settlements are much more modest, driven by economic reality to find the very lowest threshold for occupancy. Out are the great unitary structures. In are modest modular concepts that will allow growth at any pace and in any direction.

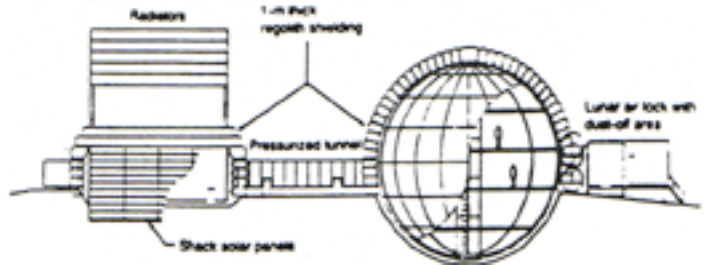

A CURRENT NASA MOONBASE DESIGN incorporates a Space Station type module [left] transportable in the shuttle payload bay and, for elbow room, a multi-story inflatable sphere [right].

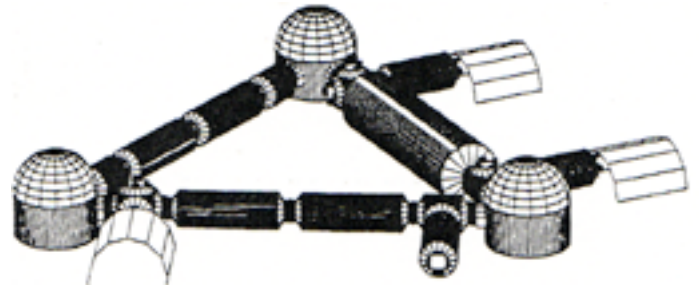

TWO MODULAR DESIGN STUDIES above and below done by University of Wisconsin-Milwaukee Architecture Dept. students working under a multi-year NASA grant:

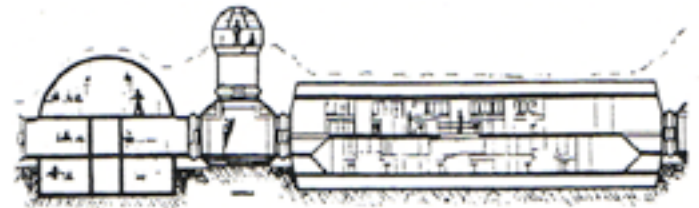

PLUSES for modular designs include ✓ most flexible growth potential; ✓ minimum need for structural counter-pressure reinforcement; ✓ tops in structural ability to contain normal 1 ATM; ✓ distributive structural failure risk.

MINUSES for modular designs include ✓ the highest surface to volume and surface to square foot ratios; ✓ very high count of leak-prone joints and connectors; ✓ highest failure mode for atmospheric circulation maintenance; ✓ very high susceptibility to biosphere inadequacy and overrun.

Improving Modularity: Clearspan Shielding

While modular plans offer great versatility for future expansion, the actual addition and/or changeout of modules can be made less cumbersome if each is not individually shielded either with “snow-blown” regolith or with cleaner-to-handle regolith-packed sacks. Instead a free-standing and open-ended “clearspan” can be built, with adequate shielding placed above to create a sheltered “lee space” below in which to park, and

connect sundry module, nodes, and passageways. Such a site shed not only offers harbor from UV, flare, cosmic ray, and micro-meteorites for the emplaced modules of the base or settlement, but for those doing the work of emplacement and hookup. 'Dozer-habitat accidents such as might occur in providing individual shielding for each new module are avoided. The EVA of construction, *once the clear shield is up*, proceeds in a "soft space" environment in which cumbersome rad-hardened spacesuits are not needed. At the same time, permanent sheltered "ramada" space is provided for routine near-module housekeeping activities: ✓ inspection for leaks and leak repair; ✓ changeout of volatile resupply tanks; ✓ tending experiment or processing packages that require vacuum but not necessarily radiation, etc. [see MMM # 37 JUL '90 "RAMADAS" and "FLARESHEDS". MMM Classics #4].

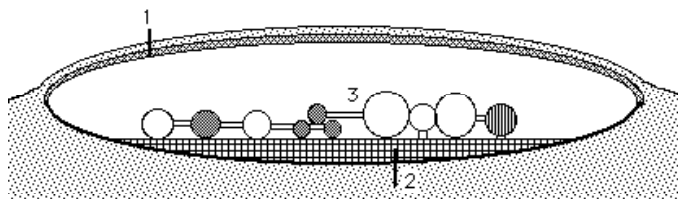

CLEARSPAN SHIELDING with modular settlement in the "lee space" below: 1 space frame to support shielding overburden; 2 framework over uneven terrain; 3 pressure hulls of modular settlement. This approach duplicates the protection offered by unpressurized lunar lava tubes in areas of the Moon where they are not to be found.

III. "Synthesis": CELLULAR Rhythm

While clearspan shielding, a simple concession to the megastructure approach, offers a quantum improvement in deployability and operation of a modular base or settlement, it still does not address the serious drawbacks of modularity mentioned above. By taking a strategic look ahead to prepare for large-scale growth of the settlement into a real xity rather than piecemeal expansion of an outpost into a base complex, we can come up with various sorts of "segmented" or "polymeric" expansion, in which each "monomer" or "xiticell" repeats the basic organic functions of the xity.

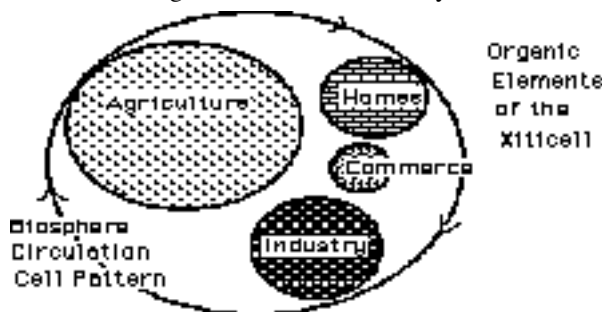

BASIC ELEMENTS OF THE XITY FOUND IN XITICELLS

By repeating these at large elements in small 'village' clusters, the Xity can start small, grow by rhythmic repetition (with adjustments in architecture, relative sizing, recycling, thermal management, and power systems as dictated by experience) to any size. A collapse of the ecosystem in one xiticell could be isolated, leaving the rest of the xity intact. Such segmentation allows evolution of systems and does not commit the Xity at large to continue systems and infrastructures and layout patterns that turn out to be unsatisfactory.

With such a xity planning philosophy at the helm, we can combine the very distinct advantages of megastructural and modular approaches, by using large scale modules to create the first and successive xiticells. For example, a residential neighborhood unit (in size and population reminiscent of one or more city blocks in American cities) could be contained in one larger scale cylindrical module as opposed to modules for each habitat plus pressurized passage and traffic connectors.

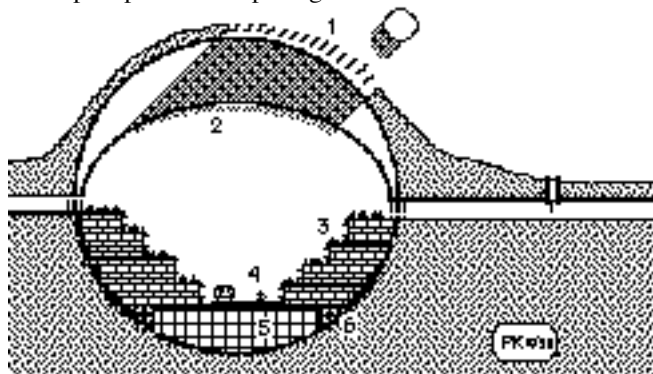

THE RESIDENTIAL STREET ('HOOD') AS THE MODULE

Cross-Section of cylindrical module 40m x 200m: {1} shield louvers that let in the sunlight; {2} a suspended sky-blue diffusing "sky" - air pressure would be the same on both sides; {3} terraced residential housing with rooftop gardens; {4} the thoroughfare running the length of the (neighbor)'hood; {5} light industry and shopping, possibly offices and schools; {6} conduits for utilities.

This scheme enables a large variety of conventional architecture for the enclosed buildings and mediates "indoors" living and work space and "outdoors" vacuum with landscapable pressurized "middoors" commons for more Earth-like living. At the same time it greatly minimized the total hull interface with the vacuum. Several such large "hood" modules along with industrial park-sized modules and farming modules are one way to form a Xiticell or basic village unit with functional biosphere, establishing a rhythm for future growth.

PLUSES for the Xiticell approach to a synthesis between megastructure and modularity include: ✓ intermediate threshold to occupancy; ✓ lessened air/water leakage vulnerability; ✓ lessened failure modes for air circulation; ✓ partially distributed structural failure risk; ✓ moderate structural counter-pressure and impact reinforcement needs and need for reduced ATM levels; ✓ intermediate flexibility of growth potential; ✓ ability to switch to better utility and infrastructure systems in new cells; ✓ reduced biomass encroachment threat; ✓ room for adjusting biomass ratios in new cells; ✓ best bet for biomass maintenance; ✓ possible phase-in of xity-center and village-suburb "metro" structure; ✓ logical extend as you grow internal cellular transit systems; ✓ 3-shift friendly .

The '89 LRS "Prinzton" settlement design, with its three villages, embodies some of these elements but involves more megastructure than the xiticell plan outlined above. The dual (or triple) helix approach to free space oasis construction outlined in MMM # 12 FEB '88 "Biodynamic Masterplan" is a better illustration.[MMM Classics #2]

Where do we go from here (a complex of individually shielded modules)? Adopting the Clearspan for subsequent early outpost expansion would be a start, switching to larger xiticell-organic modules next.

MMMA

Mars of "Lore" vs. Mars of "Yore"



At left: Mars as Percival Lowell saw it, crisscrossed by canals, a dying, drying world that once had a thriving biosphere and given birth to a sentient race.



"Martians" had since adapted to the thinning air and dwindling water reserves, building a network of irrigation canals. At right: Mars 3 billion years ago, with its northern ocean. Today it is a far more hostile place than either. Should efforts to make Mars more hospitable seek ambitiously to restore the Mars of Yore - or settle for the Mars of Lore? ⇒ below.

[IN FOCUS Editorial]

MARS: plenty of time to wait, but none to waste

Plenty of Time to Wait

Most of us in the National Space Society see the make-or-break importance of putting our expansion into space on a firm economic footing and we view development of lunar resources as the first step to achieving that goal. Yet most of us also have a keen interest in Mars, its exploration by human crews, and its eventual settlement. While President Bush has espoused such a goal, economic realities are certain to put off its achievement for decades, like it or not. Even a magnitude of order reduction in NASA's original cost estimate of \$500B via Bob Zubrin's "Mars Direct" mission architecture still leaves human exploration of Mars a luxury. Once the potential for off planet resources from the Moon and elsewhere to substantially alleviate Earth's growing energy crisis is more widely realized, this will change, with retrieval of volatiles from Mars' moonlets, Phobos and Deimos, part of the scenario. Martian settlement will piggyback on that resource trade *or not occur at all*.

Meanwhile things do not look well even for robotic precursor missions to Mars. Mars Observer, much of its original potential lost when NASA cut the NIMS instrument as a penny-wise pound-foolish budget move, is set to lift off soon on a Titan using the unproven and inadequately tested TOS kick motor. We can only hope that Mars Observer will not be yet another victim of tragicomic human error, adding to the sorry string that now lists *Phobos*, *Hubble*, and *Galileo*.

Meanwhile the former Soviet, now C.I.S. Mars program has been cut back and delayed. Until the Euro-Asian Commonwealth economies improve dramatically, we can be thankful for any missions that are actually launched.

No Time to Waste

Those who wait for transportation cost breakthroughs and do nothing else in the meantime to help ensure the success of eventual Mars missions, work instead (in self-betrayal of **Meteorburst Communications** - Design light-weight equipment to be included on a Mars Surface Rover to attempt to

relay signals to distant receivers over the horizon by bouncing them off meteorbursts in the high Martian atmosphere much as truck fleets now do on Earth. If successful, this would allow planetwide operations without the necessity of deploying and maintaining an expensive array of communications satellites. A good project for ham radio buffs.

Carmonox and Methanox Engines - Develop, debug, and improve internal combustion engines (for vehicles and generators) that can run on Carbon Monoxide and Oxygen or on Methane and Oxygen in simulated Martian conditions. These fuels can easily be extracted from the local atmosphere and cached at handy points to bring real mobility to Martian operations. A pair of good project for the automobile engine buffs amongst us, or for school projects.

Skimmers - Earthstyle hovercraft will not work in the thinner Martian atmosphere unless a large portion of their standing weight (with fuel, and without) is neutralized by gaseous hydrogen buoyancy tanks. Maintaining stability in maneuvering, and maintaining ground clearance range as fuels are used up will be a design challenge. If you have the capacity to tinker up a suitable Mars skimmer and don't, don't cry when our people on Mars are dependent on torturously slow walkers or crawlers when they could have been making tracks.

Canals for Polar Meltwater - One should never put all one's eggs in one basket. As permafrost may prove not to be an easily recoverable resource, we need to brainstorm how to access the much greater water reserves within the planet's polar caps. Do we truck quarried ice to distant bases and settlements? Or do we finally build the vaunted canals of Mars, once prematurely accepted as fact? If so would these be pressurized conduits carrying melted ice water with periodic pumping stations and measures to keep the water from freezing (such as solar heat-attracting and storing surfaces)?

CHEMICAL ENGINEERING PROJECTS

Igloo Type Shielding - Dinitrogen Pentoxide (N₂O₅) produced robotically from the surrounding atmosphere without disturbing the surrounding soil of the base or settlement site, would make deployment of either, a much simpler task and produce other useful volatile feedstocks as byproducts. We need to brainstorm the most appropriate chemical pathway for producing this stable radiation-shielding powder under Martian conditions and with a minimum of tending.

Once we have a much, much better handle on what types of mineral and chemical compositions occur in how much relative abundance in the various areas of Mars, it will be time to start brainstorming the processing of building materials and other products from local resources. As of now, such work would be premature - garbage in, garbage out.

Climatic Engineering by design - By now we know, having learned the hard way, that human industrial activity has a definite changing effect upon the terrestrial biosphere. While the effect of our presence and industrial activities on Mars will be minuscule at first, they will be real. On Mars the situation will be just the opposite. We will want to maximize, not minimize, climatic change-effecting byproducts of our activities. But first we must decide what our "terraforming" goals are. Some of the potential pathways may be mutually exclusive. It will be important not to put in place operations

that will unwantedly commit us to temporary but “dead-end” greenhouse improvements. See the article that follows. The result of this discussion should be to have in hand, when we finally do set up on Mars, a well thought-out **strategic exhaust gas policy**.

AGRICULTURAL PROJECTS

Mars-Hardened Plants - At the present epoch, Marsair is too cold, too thin, too dry, and too naked to raw UV to support any kind of plant life useful to settlers that we can easily imagine. Yet condensed and warmed in moisture tight greenhouses under UV resistant glass, Mars’ Carbon Dioxide - Nitrogen atmosphere (95%, 3% respectively), a small amount of Oxygen added, should support agriculture easily enough. It’s not too early to begin breeding and bioengineering (transplanting genes that promise success) plants that “thrive” in such conditions, gradually hardening them to ever thinner, cooler, drier, and less oxygen-rich conditions until one day, as human planetary engineering improves the climate on Mars, they can establish themselves outdoors and spread, creating the first (in a very, very long time, to be sure) Martian ecosystems. Meanwhile crops grown in such conditions will provide food, fiber, and feedstocks much more cheaply than those that have to be babied in more Earthlike greenhouse conditions.

An important consideration in the above scenario is the choice of plants that are not dependent for pollination on insects or other animals that could not survive in such anaerobic (oxygen-starved) conditions. Mars will have flora outside the greenhouse *long* before it’ll have fauna outside the zoo.

PROBE INSTRUMENTATION PROJECTS

If we are going to settle Mars, living off the land in true frontier style, we must have in hand a much better picture of the nature and geographical extent of potential Martian resources. Our past probes, and those now in the works, both U.S. and C.I.S., are aimed less at resource identification and mapping, than at the intellectual self-gratification of the principal investigators enlisted in the effort. This knowledge is not spurious. It does provide a foundation for further exploration. The point is that if we do not see to it that future probes are adequate to the job we who would settle Mars need them to do, we cannot sit idly by and leave the choice of instruments and the scope of missions to planetary scientists planning alone.

A **Permafrost Explorer** needs to be brainstormed. By first scouring over existing Landsat thematic imagery to find clues to Siberian, Alaskan, and Canadian permafrost - here on Earth where ground truth checks and calibrations are an easy matter, a project team should be able to get a handle on how to design a Mars probe that would do the trick, outlining the extent and perhaps giving clues to the thickness of subsurface ice-laden soils on Mars. A spin-off *precursor* dedicated Earth Permafrost Explorer would be a funds-attracting possibility.

Carbonate Explorer - Orbiting thematic mappers might be optimized to expose calcium carbonates (limestones) in the soil and other depositories of carbon dioxide that could be used to *rethicken* the atmosphere. It is even possible that there exist karst regions of long dead limestone caves preserved through the disappearance of running water.

Thermal Explorer - An orbiter could be instru-

mented to map the relative heating and cooling (post sunrise and post sunset) capacity of various areas and to reveal geologically active hotspots that could be tapped someday for geothermal power production.

Future topographic mappers could be made sensitive enough to reveal ancient shorelines and beaches, tiny head-water sources and eroded badlands. Chemical mappers might be made sensitive enough to reveal salt deposits, clays and other rusted and hydrate-rich soils as well as hydrogen depleted soils.

The implications for all this knowledge for base and settlement siting, for architecture, for industry, and for agriculture cannot be underestimated. Without such knowledge, we will founder about blindly, losing decades. NSS has several members with at least some of the germane expertise to take a more aggressive tack in planning the future of Mars precursor missions so that when we do go to Mars, we will have gone to stay, really.

These are just a few items of an ambitious homework agenda to make the waiting years anything but wasted ones. As we identify more in MMM, we will add them to this list. But the choice is up to us as individuals and subgroups, since the NSS Board seems disinterested in doing anything other than affecting public policy.

PK

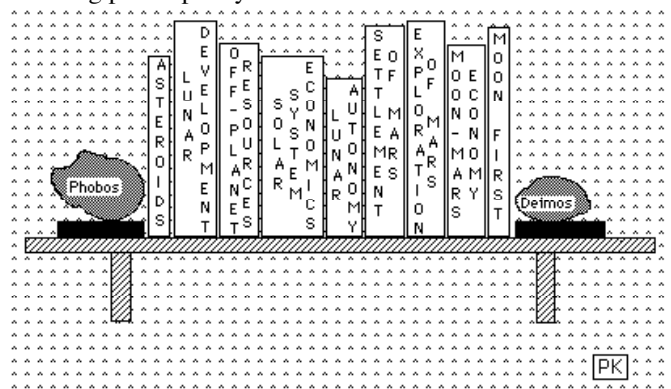

INVENTORS WANTED

Serious would-be explorers of Mars have been busy developing a variety of wheeled and walking vehicles and robots to cover the boulder-strewn expanses of Mars.

The trouble with wheels, is that they are too easily defeated by a host of obstacles. Mars has no roads. Yet walkers can negotiate easy terrain at only a snails pace. So why not combine the virtues of both? Tinker a walking vehicle that can let down a set of wheels when the way gets easy, or a wheeler that can switch to legs, or whose tires can sprout feet?

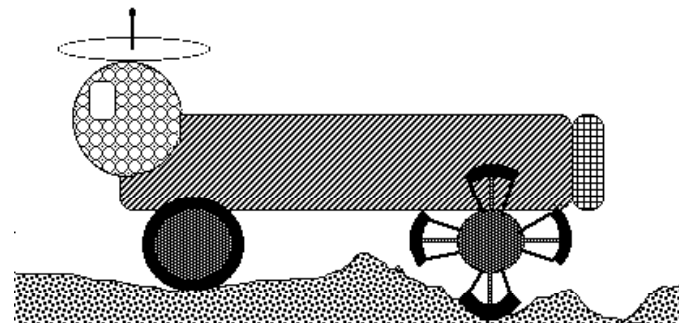



To date, the discussion can be summed up by the phrase “garbage in, garbage out”

By Peter Kokh

When the popular wisdom that Mars was a dying planet populated by an ancient race that has struggled resourcefully to keep apace with the advancing desiccation of its lands and the thinning of its air with a grand engineering scheme of canals to bring melt water from the polar caps to thirsty equatorial croplands and of atmosphere plants to keep the air as thick as possible - when this notion finally fell before the onslaught of better telescopes, less romantic observers, and an armada of visiting probes, many a writer made up for his aching disappointment by concocting schemes to make this drier than we thought, colder than we thought world something more like Earth. “Terraforming” is the word in currency. And the number of daring bold schemes is legion.

There are two things wrong with these schemes. *First* there has been little if any consideration for where the planet has been (should the goal be rather one of restoring the pristine youthful Mars of yore i.e. “**rejuvenaissance**” rather than “terra”forming, bringing it to a state alien to its experience?)

Second there has been much detailed consideration of importing apparently missing volatiles (notably water-ice and oxygen) and little consideration for what resources are actually banked on the planet itself in one form or another. Indeed we do not know the answer to that and a whole armada of probes will be needed to tell us what level of improvement we can achieve *working with the grain of Mars*, rather than against it.

Indeed such information may well make clear that we could, without grandiose schemes to import ice from Hyperion or elsewhere, *ease Mars back*, if not to the ocean-mantled days of its youth, at least to the marginally survivable world we thought was our neighbor some decades ago. Yes, why not “**Lowellification**” after Percival Lowell whose inventive picture of Mars so many had so eagerly swallowed hook, line, and sinker - a vision of broad irrigated croplands beside wide open canals, of the spring advance of green from poles to equator, of air not so thin that a simple breathing mask wouldn’t do, of deep blue skies to offset the rust-hued sands.

In fact, we may not need to import ice from elsewhere

in the Solar System to give Mars new seas. We won’t know that until we’ve orbited a **Permafrost Explorer** and a companion fleet of ground truth seeking robots. Yet no nation has gotten past the “wonder if” stage of curiosity about permafrost. Without advocacy we may never get to know. For it is the relics of the past, not the foundations of the future that causes planetary scientists to itch, and seek federal scratching aids.

In truth, we may not need to import vast quantities of oxygen and nitrogen to transform the atmosphere if orbital and surface exploration reveals vast buried fields of carbonate rocks or even limestones. We haven’t heard of any plans to research these pregnant possibilities. For if we could thicken the given carbon dioxide atmosphere, we’d have a warmer Mars, one on which some frozen water reserves would melt and stay liquid, and one on which, a trace of oxygen added [%?], plants not dependent on animals or insects for pollination could thrive - even if we still could not breathe the stuff ourselves.

And if, no thanks, we would rather move towards an oxygen-laden nitrogen-buffered atmosphere like the one in which we have ourselves evolved, we may have an assist of unknown potential in the surface peroxides of unknown depth and extent that the Viking experiments hinted at. Can we get a handle on this question from orbit with the help of calibrating ground truth devices on the surface? Those who would go beyond exploratory orgasms to real settlement, owe it to themselves to advocate the missions that will tell us yea or nay.

We may or may not ever have enough raw power at our disposal to undertake the grandiose terraforming schemes bandied about in the past three decades. But we will certainly have an effect on Mars, as we have had on Earth, by our growing industrial presence there. Even before we have the wherewithal to begin tackling a more modest program of “Lowellification”, we will have the option of designing our industrial processes to maximize the kind of benign exhaust “pollution” that would slowly build up to the threshold for permanent climatic change for the better.

Decisions will have to be made in the next few decades, as soon as possible, about what our goals are for Mars - for the various paths are not all stages of one grand scheme. If we will settle for a much-easier-to-implement thicker CO₂ atmosphere with a relatively small amount of free Oxygen and accept a Mars-hardy vegetation without wildlife (we’ll have indoor pets and “middoor” urban wildlife to be sure) then the industrial protocols we need to put in place from the gitgo will be quite different from those that would support a path to a more Earth-like final result.

Before we pick sites for our settlements, we had best make sure they are not smack in the way of some eventual river, or on the bottom of some future sea!

If we purposefully take the first humble steps to a future wetter Mars, then, before we pick sites for our settlements, we had best be sure they are not smack in the way of some eventual river, let alone on the future bottom of some sea to be. Indeed, we have a very poor map of Martian topography and the relative elevations of various areas. Mars was not wet enough long enough to have developed a mature drainage system - even if it did have a pole-girdling northern sea,

Oceanus Borealis, and even if it did have catastrophic flooding in a few scattered episodes. Mostly Mars will be a place of separate unlinked basins whose lowest sills have never been breached. Not only do we have to have an excellent basin map, we have to know what the soil composition of various basin sills are, and the ease at which water can cut a channel through them. Only with a lot more information than any curiosity-scratching planetary scientist has ever proposed to seek could we program a computer to sketch the likely evolution of Mars future drainage systems.

Not only do we not want to place a major Martian settlement in the way of some future watercourse, neither would we want to isolate it in some future boondocks nowhere near one of the future rivers, lakes, or seas. There are a few safe bets, of course. On the rim of Valles Marineris, or on the upper flanks of the deep Hellas basin.

Any intelligent plan to settle Mars needs to know what resources are available and where they are to be found, in search of a healthily diversified economy. By these standards, we have not yet done enough homework that any plan for opening Mars could expect more than a pathetically flunking grade. The location of future Martian towns and cities, the “language” of any native architecture taken from the building materials that can be produced from indigenous resources in various soil provinces of the planet, even the kind of “forests” and “scrub” that we may someday be able to develop to grow wild and free under Martian skies, and the produce and fiber we may be able to harvest from such de-tamed varieties - all hangs in the balance. For it will depend heavily on the informed decisions we make on the direction of planetary changeover that economic micro-decisions will move us towards. The pace of that change may be slow but it will be inexorable.

Above all, we must be sure that we do not develop habits on Mars that start us up some dead-end canyon of foolish short-lived improvement. We must leap into the future from a platform of solid investigation.

Terraforming, Rejuvenance, Lowellification? The burden is ours, not to decide, but to begin the methodical accumulation of the information on which an informed and timely decision can be based.

Terraforming, Rejuvenance, Lowellification - whatever course we would choose - are not mere exercises of fantasy speculation. Nor do they represent choices we can leave to our successors in some latter century. The time is upon us, not now to decide, but now to begin methodically accumulating the information on which an informed decision can be based in a timely manner. Once a goal has been agreed upon, there will be time enough to decide upon the actual means. Meanwhile, sorry to disappoint those looking for an ‘MMM special’ quantum leap in speculative planetary engineering. As we said, at the present moment it’s a case of garbage in, garbage out. And if those of us who ought to care, do not take needed steps, that situation will continue.

We can *chose to be the ancestors* of generations of Martians yet to be born.

FRAMM

[Series Continues]



Pronounced KSIH-tees, not EX-ih-tees

[Human communities beyond Earth’s cradling biosphere]



By Peter Kokh

Part II: Last month, because of the shortened 12 page version of MMM # 53, we had to cut our discussion short, with much of what we had wanted to say left unsaid. Here’s the balance.

If the trouble with megastructures is the very high construction threshold before first occupancy can begin (the biosphere retaining shell has to be built all at one) the trouble with the micro-modular concepts now in vogue is, on the one hand, the very high surface to volume and joint count to volume ratios (multiplying, without real compensation in any cost to benefit ratio, unacceptable leakage rates and the chances for decompressive failure) and, on the other hand, a convoluted layout with many constrictive points, all of which must work against free atmospheric circulation within the settlement’s mini-biosphere. The cramped spaces of the micro-modular settlement are apt to leave much too little space for vegetation (which should play the host to humans, not the other way around) and all of that, likely in food-production modules not adequately integrated with the whole complex.

In any biosphere, vegetation should play the host to humans, not the other way around

Our suggestion has been to move to larger “block” sized modules (intermediate between building size units and settlement-sized megastructures) all of which would have an important place for vegetation, each module contributing not just to the settlement economy but to its biospheric self-maintenance. To do this, we need to move quickly beyond shuttle payload bay-sized sardine cans [limit is 15 x 60 ft], shuttle external tank or Energiya sized modules [27.5 x 97 ft], beyond simple inflatable spheres and cylinders, to modular prefab construction with building elements manufactured on site on the Moon, or Mars, or asteroid as the case may be. A facility that can spin integral cylinders of glass/glass composites [glax] of as large a diameter as can be transported locally (assuming the factory does not itself move) should be a high priority.

Given such a capacity, the settlement could grow one large module at a time. Such modules should be used not only for residential neighborhoods, nor only for agricultural areas, but also for for well-greened commercial and industrial space.

Even the connectors should be relatively generous in cross-section, providing, religiously, space for vegetation as well as traffic. Such connecting trafficways should have at least the girth of the ET e.g. 27.5 ft, which might allow them to be constructed of salvaged cargo holds. To illustrate:

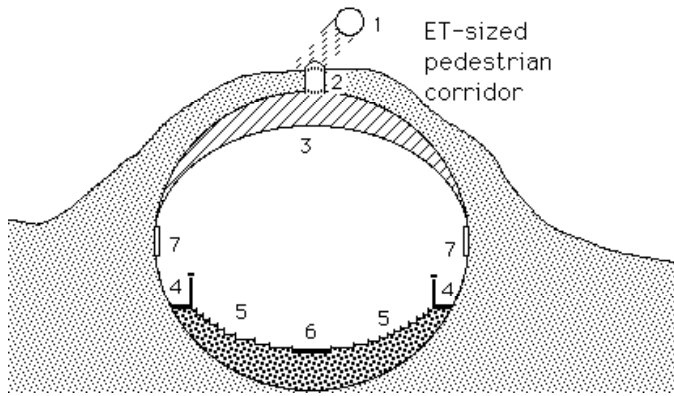

KEY: (1) Sun, (2) fiber optic bundle sunpipe, (3) sky-blue sunlight diffuser (same air pressure either side), (4) pedestrian walkways, (5) terraced plant beds, (6) gardener's path, (7) art and poster gallery.

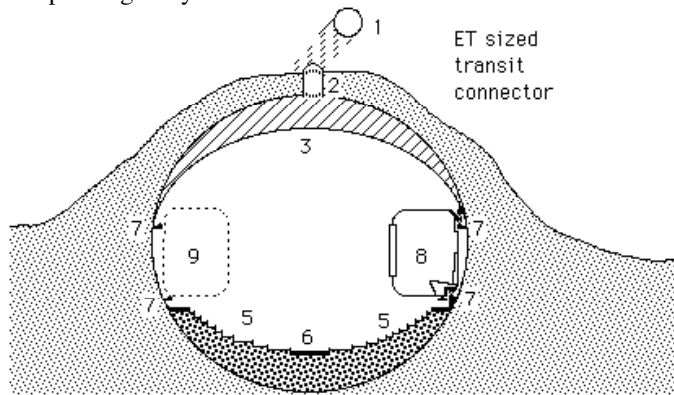

KEY: (1, 2, 3, 5, 6) as above. (7) wall-mount rail suspension system, (8, 9) bench seat transit car.

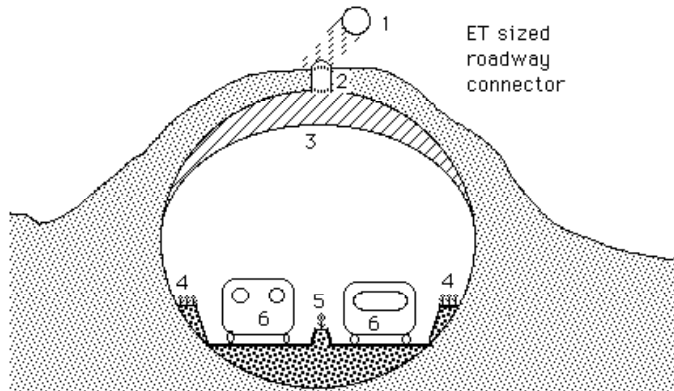

KEY: (1, 2, 3) as above. (4) plant bed and hanging garden, (5) planter-topped divider, (6) vehicles. In all of these connector examples, there is a place for vegetation, and the more place the better. It is more than a matter of morale, the comfort of mothering greenery against the stark sterile barrenness beyond the settlement airlocks. It is a matter of always paying heed to the overriding requirement to maintain a healthy and integrally functioning biosphere as a host to all other activities within the settlement hull complex.

Polymerization - Growth Patterns

Given properly functional-sized modules, how should the settlement, any settlement, grow? Should growth be helter skelter, unplanned? Or are there good reasons to suggest some patterns of add-on connectivity over others? As with terrestrial cities, the lay of the land will supply some sort of template, but

perhaps to a lesser extent. Unlike Earth cities, cities on the Moon will not be nestling along river banks or seashores. On Mars, the siting considerations become more tricky and the potential drainage channeling of current dry land will have a say on the directions of settlement expansion. In free space, modular settlements will follow their own internal logic, one in which the principal consideration is the chosen radius for centrifugally provided artificial gravity.

But back to surface settlements. Let's consider as thesis the linear model of expansion. We simply add modules end to end in one long line. This has the advantage of making a spinal transit system simple and functional. The disadvantages are first, the overall damper on physical networking as the mean distance between any two sites (and citizens) grows linearly with the population. Second, the long and narrow overall complex makes a circulating atmosphere quite a plumbing problem.

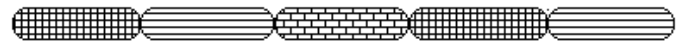

Linear Growth Pattern: Modules placed end to end.

The antithesis, then, is the crystal lattice, where the average distance between sites and citizens grows only as the square root of the population, i.e. as the radius of the cluster of modules. The atmosphere can circulate and the biosphere can function more integrally. On the other hand, any sort of mass transit or people-mover network becomes more complex. Further, instead of two points of growth, the crystal has many points for growth. This can be a plus. It can also be a political nightmare.

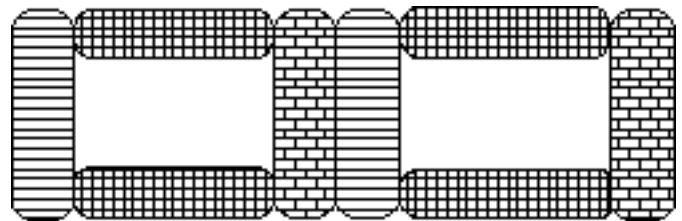

One of many possible "crystalline" growth patterns for the modular settlement

The synthesis may be a pattern taken from nature, one in which the assets of linear expansion and self-clustering are elegantly co-"promised", i.e. the spiral pattern of the snail, the nautilus, and other creatures. Here a single spinal transit nerve just keeps growing from one end, while radial connectors keep everything compactly close at hand.

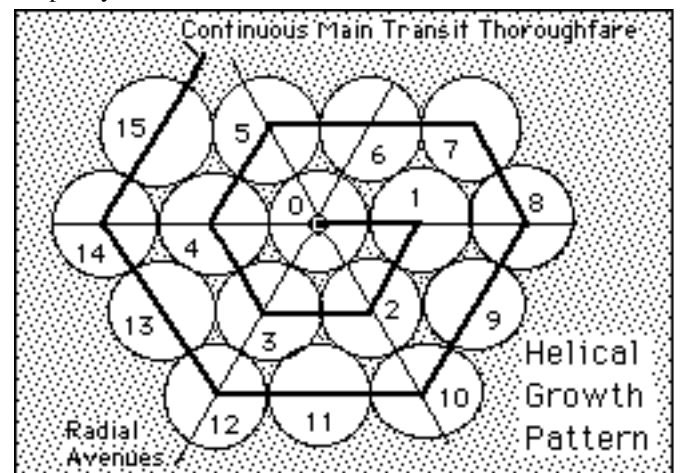

KEY: Order of construction 1-15 etc. with 0 being reserved for a metro downtown that can be added whenever needed. C would be the central plaza and eventual origin of the transit corridor. There is no limit to potential expansion

Such considerations may be foreign to cities on Earth. Off planet, all human settlements will be behind the eight-ball and will need every advantage for efficient functioning that they can draw upon.

Used to best advantage, the helical pattern will unite not individual modules, even modules of size, but “xiticells” or clusters of modules in which all the basic elements of a functioning Xity-with-biosphere are represented and repeated. To be sure, as sketched below, this concept seems a little utopian, but elements of it are sure to recommend themselves to future Xity planners and architects on the space frontier. 

[Continuing with this month’s topic.]



By Peter Kokh

The first settlement on Mars will probably be built on some committee-chosen site that has no justifying rationale at all to anyone looking at Mars from a long term global perspective. Such is the way governments do things. Xitizens and business people looking to found follow-up settlements will be much more strongly motivated to choose sites that offer distinct and inarguable economic advantages. For example, a position astride an obvious future traffic route, or near known or strongly suspected local resources of Mars-global significance, or near local energy access sites (polar meltwater-run hydroelectric? geothermal?) or, convenient to premium tourist attractions.

It often seems, even to lunar development advocates, that the Moon is very homogeneous and monotonous, that, to put it tritely, “when you’ve seen one crater, you’ve seen them all.” Yet various lunar sites do offer distinct advantages and the Moon cannot be developed in any rational way by a single base or settlement no matter how respectably sized and thoughtfully situated.

If that is true on the Moon where eons of geological processes in the presence of water did *not* occur, the economic geography of Mars, where water flowed freely for perhaps a billion years, is likely to be far more diversified in its economic relevance. Strategic metals may well have begun to be concentrated into ore bodies in various places. These may be exposed here and there in the walls of various canyons, favorite early sites for prospecting. The permafrost will be much more accessible in some areas than others. Very low areas like the Hellas basin will have noticeably higher atmospheric pressure, etc.

At this point we have a much better idea of the kinds of building materials that we can make from Lunar resources than may be possible from Martian ones. Given the almost certain high degree of variation in mineralogical content from

place to place on Mars, even the most educated guesses as to the kinds of construction products we can produce on site are in all honesty little more than exercises of unanchored speculation. As a result, far more than on the Moon, various Martian towns may differ markedly in architectural appearance.

Beyond such a blatantly general statement, it is still possible to say some interesting things about future Martian Xities. First, since the degree and mix of exposure to the cosmic elements differs, shielding requirements will be both less and different from those on the Moon. The thin atmosphere is a poor blocker of cosmic rays and it has little screening effect on the strongly antiseptic solar ultra-violet radiation. But this tenuous envelope does stop most micro-meteorites and the danger of impact decompression accidents may be a bit lower. There is every reason to believe that the air pressure can be increased substantially by using Mars’ own indigenous resources.

Shielding needs can be served in the same manner as on the Moon, using local regolith. This will be harder to accomplish if all sites are as boulder strewn as the two visited by the Viking probes. But there is also the elegant possibility of processing an insulating powder directly from the atmosphere - Dinitrogen Pentoxide or N_2O_5 [see MMM # 42 FEB ‘91 “IGLOO Shielding on Mars”. See MMM Classics #5] To keep it from blowing away in the Martian winds, this powder would have to be covered with an anchored tarp or placed in bags, or simply in sufficiently voluminous hollow walls and roofing.

One site that has a lot going for it, the west slope of lofty Pavonis Mons on the equator, may also come equipped with ready made shelter in the form of innumerable lava tubes honeycombing the bulk of this great shield volcano. [cf. MMM # 18 SEP ‘88 “Pavonis Mons”. MMM Classics #2] [See request for proposals at the end of this article.] While there are extensive dendritic valley complexes most likely carved by flowing water billions of years ago, a Martian analog of a Lunar rille bottom settlement [as in LRS’ ‘89 Prinnton design competition entry] may be inadvisable if there is any chance at all that through human action the waters could flow again. Yet, as the atmosphere thickens slowly through planned industrial out-gassing and more swiftly through deliberate direct action, once the Martian economy can support such an effort, the settlers will be able to spend more and more time outdoors without overexposing themselves.

While shielding will still be a must, Martian xities need worry less about being air-tight, on two grounds. First, leaking oxygen into the surrounding atmosphere will help contribute to desired slow change in atmospheric composition. (On the Moon, similar leaks would degrade a scientifically and industrially invaluable high vacuum.) Second, whereas any leaks on the Moon would result in the loss of Nitrogen which may have to be imported to the Moon at great expense, similar leaks on Mars will lose nothing that can’t be replaced locally.

While the practical differences are slight, Martian settlers may be less accepting of a “mole” type life (even with piped in sunlight and periscopic picture windows) than will be frontier folk who settle the harsher Moon and asteroids. Domed xities - even if the dome-facing walls of the buildings inside have to be shield-thick - may be the Martian settlers’ common dream vision of the future, with some slow relaxation on the

annual permissible number of unprotected hours outside.

Given the comparatively relaxed concern with closing the atmospheric and water cycle loops on Mars, smaller rural outposts will be much more practical than they will be on the Moon where there will be a much stronger biospheric advantage to size. [MMM #15 MAY '88 "Rural Luna." MMM Classics #2]

Because wood and paper and plastics do not contain elements that are deficient on Mars, such materials can provide some of the building materials and furnishings and arts and crafts objects used in the settlement. In that respect, Martian burgs will be far more reminiscent of those on Earth than the glass, metal, and ceramic dominated lunar towns and habitats. Along with this benefit will come increased danger of fire.

Finally, unlike almost everywhere else in the Solar System beyond Earth [Europa and Titan may be two eventual exceptions very far down the road] Mars may someday (again?) sport a global biosphere of genetically nurtured adaptations of the hardiest Earth plants. Thus where all other Xities provide a firmament between contained biosphere and sterile and barren surroundings, on Mars xities will contain oases of Earth life surrounded outside by fledgling Mars-hardy adaptations. Towns on the red planet may actually someday get some of their food and other agricultural needs from outside their xity biospheres. 

Attention Technonuts, Software buffs REQUEST FOR PROPOSALS:

Problem: How could Microbot Lavatube Mappers do their job within the maze of lavatubes that probably honeycomb Pavonis Mons and other Martian shield volcanoes if they're at all like their much smaller cousin on Earth, Hawaii's Mauna Kea/Mauna Loa (i.e. the Big Island, where incidentally they could be field-tested - as well as in the Oregon Moonbase) *without* losing their bearings under-ground, *and without* losing contact with their central control and information dump?

Answer: Let us know how *you* would design an army of robo-ants to thoroughly map and explore the suspected lavatube complexes on Mars. Assume that the mechanical critters will deactivate when they reach an obstacle or dead end and not return for debriefing. The "Reporting Center" may be on the surface or in synchronous orbit above the mountain.

MMM will publish the best suggestions submitted. COPYRIGHTs remain with the submitter, as usual. 

GLOBAL ACCESS to MARS the WORLD

By Peter Kokh

We will not have established a *real permanence* on Mars *until* we have made a start on an network of strategically scattered settlements, each differently advantaged by the geography and/or geology and mineral wealth of its site - as a down payment on a Diversified Economy that can supply a healthy percentage of its own needs and produce enough goods

for export to purchase what the Mars Frontier jurisdiction cannot yet provide for itself. It is not enough to go beyond human exploration to the establishment of an outpost, however ambitiously designed. The permanence of that outpost will be so much wishful bravado against the harsh economic night until our presence on Mars becomes a real, rooted global occupation. As we've pointed out, we have a lot to learn about Mars, information that will not be gathered from the idle curiosity scratching probes now in the planning stages, before we can begin to glimpse what such a network of frontier towns would look like or the details of its economy.

What we *can* do, while we are trying to escape owning up to our responsibility to get involved in advocating the needed set of Mars Resource Explorers, is to brainstorm, tinker, and field test various potentially promising means of transportation that settlers can use to negotiate their roadless and trackless raw new world without having to stop to build the traditional road and rail networks. These will come in due time as the initial experimental traffic settles into patterns and volumes that justify their construction.

Aviation - "Ares Aero"

Several promising suggestions have already been made. Several writers have pointed out the possibility of aviation in the thin Martian air. Baseline "sea level" air pressure on Mars is equivalent to that 125,000 feet up (38,000 meters, or 24 miles) here on Earth. A neat trick, but well within the envelope pioneered by a number of experimental aircraft to date. The most challenging aspect of aviation on Mars will be taking off and landing. Without lift-assist, such maneuvers may have to be made at speeds up to 700 mph or 1100 kph. Launch track acceleration might help, but landing at such speeds would present a formidable performance assignment for Firestone or Goodyear.

For this reason, much of the discussion now centers about combination dirigibles and aircraft in which enough of the weight of the craft is neutralized to permit operation at significantly lower speeds. On Mars where there is no free oxygen, certainly not in quantity, to support combustion, designers can specify **hydrogen for buoyancy** with four times the lifting capacity of helium, and far more readily available to the technology of the early settlement.

There is a primer discussion of these possibilities in The Case for Mars II proceedings (1985) pp. 489-96 "Dirigible Airships for Martian Surface Exploration" [AAS 84-176].



Hybrid Mars dirigible aircraft
Thick Delta Wing holds hydrogen gas, is shaped for speed. *M. Clapp*

We strongly encourage space advocates who may also be aeronautical engineers to get involved in this preliminary brainstorming, so that all the potential pathways can be explored. At least at first, settlers would need a family of "lightened" aircraft that could operate with a minimum of ground support, as they did on Earth in the pioneer days of aviation during the Oughts, Teens, and Twenties.

Presumably, such aircraft would have rocket engines (the air is too thin for props except for ultralight drones) be fueled by burning methane and oxygen, both supplied in tanks

since oxygen can't be extracted from the air in flight at volume rates anywhere nearly sufficient. Such a fuel will require a substantial ground installation to support each refueling site.

This creates a burden. Either we must develop a compact efficient fuel-processing plant that can be produced in quantity on Mars (or at least the more massive, simple, and most tolerance-forgiving of its components) for drop-off-and turn-on deployment at uncrewed sites. Nuclear or solar power could supply the energy needed.

The alternative is to use an aircraft engine that can run on a fuel that the aircraft can produce with a much smaller and lighter weight power plant on board the craft itself.

NIMF - Nuclear rocket using Indigenous Mars Fuel

As already reported in MMM # 30 NOV '90 "NIMF" [Available by SASE + 50¢ from MMM Reprints c/o the LRS P.O. Box.] Martin Marietta's Robert Zubrin [a candidate for the NSS Board of Directors] first suggested how a Mars landing craft could refuel itself from the Martian atmosphere with an *on board* power plant and use that fuel to make exploratory sorties to distant sites on the planet. Second he suggested (with the help of illustrations by Martin Marietta artist Robert Murray) two configurations: a ballistic hopper, and a winged shuttlecraft that looks a lot like its currently flying Earth-LEO ancestors Columbia, Discovery, Atlantis, and Endeavor. This craft would use 4 VTOL (Vertical Take Off & Land) engines to allow Harrier-like landings and ascents to and from Mach 1 flight. This avoids what could otherwise be an extremely heavy burden for the early settlements: grading and paving landing strips. Whatever your reaction to the use of nuclear power plants on Mars, this is the most versatile Mars-global transportation system yet suggested, one which can be put into place at the very outset and used to establish scattered sites, not merely support them once established.

Ground Effects Vehicles - the Skimmer

For many exploration and routine transportation needs it would be far more useful to (also) have a swift means of surface, or near-surface, transportation. The two sites we've visited via our Viking proxies have displayed daunting strewn-fields of variably sized boulders. We don't know how typical this is of Mars but our best guess might be "very". This will make the going rough and slow for wheeled vehicles, though several interesting designs are in circulation and a number of contractor and university built prototypes actually field-tested. Many designers have despaired and turned to walking vehicles instead. Whatever the view from the ivory tower, to the explorer and/or settler on Mars, either choice will provide exasperatingly slow, tedious, and patience-testing travel at best. Without going to all the trouble to grade roadways to places we may not want to visit again any time soon, there has to be another way. Mission planners on Earth may not care, but those of us who would earn our place as spiritual ancestors of the actual settlers to follow, should.

Can a Mars hovercraft be built? Remember the air is very thin and even compressing it somewhat under flexible skirts is not likely to produce enough lift to do the trick - unless, that is, we "lighten" the effective marsweight of the vehicle itself by hydrogen-filled buoyancy tanks. Even so, we

are left with some interesting challenges. First, whereas traditionally supported ground vehicles can be "loaded up" with fuel and cargo to the fairly generous limits of its suspension system, a Martian "skimmer" which had say 90% of its weight neutralized by hydrogen tanks or ballonets may not be able to operate effectively if it was heavily fueled, or took on an honest load of cargo. A skimmer which can perform well on near-empty once around the parking lot but not at all under real service conditions would be useless. One approach would be to mate extra buoyancy tanks to each cargo container to be loaded and subsequently unloaded. But that still leaves the problem of how to compensate for fuel weight loss while operating. Of course, valving out some of the hydrogen would compensate - and that may be the only ready answer.

Second, supposing that the weight of craft, fuel, passengers, and cargo is 90% (or whatever the best figure turns out to be - we drew that one out of a hat) hydrogen-neutralized, can it negotiate the usual size range and spacing of the ubiquitous rocks and boulders?

Third, how well can it maneuver? Lightening the weight *does not* reduce the momentum! Our guess is that all of these challenges can be met, once the sofa cushion approach is abandoned. Designing and debugging a Mars skimmer would be a great competitive task for college engineering classes (and fraternity members who may want a diversionary break from elbow-bending), in a design challenge *with a prize*, in an event worth re-running (like the Australian solar-powered car race).

Skimmers could do for Mars what the automobile has done for us - provide cheap on demand mobility. They could be configured as individual/family vehicles, as motor coaches (Martian Greyhounds), and as Trucks (Lorries, if you will). Aircraft will do a lot to help establish Mars as a multi-site world. But only ground vehicles can really make things tick.

Eventually roads *will* be built - at first within the individual towns and outposts, then serving the immediate vicinity, finally linking distant communities. But for a some time in the early frontier decades, it will help a lot if a simpler infrastructure-light means of transportation can be made to work until the infant Martian economy is well enough along on its agenda of growth and diversification to permit the diversion of substantial resources to road- or rail-building and other infrastructure-heavy transportation modes.

If you are a Mars person with technical ability, why not make it a new hobby of yours to tackle some of the above challenges? **EMMA**

MMM #55 - MAY 1992

Beyond "Mole Hill City"



Our expectation of what a Lunar Outpost or Settlement might look like from the vantage point of a surface overlook has become one of a monotonously drab pattern of regolith

mounds, the tell-tale sign of pressurized living space below. This “molehill-scape” is little relieved by its punctuation with occasional observation cupolas, exposed air locks, solar arrays and heliostats, peripheral tanks of volatiles, and other external ware-housing. “Once you’ve seen one moonburg you will have seen them all.” *Not necessarily so!* Eventually Lunan architects will rise to the challenge. ⇒ below.



Pronounced KSIH-tees, not EX-ih-tees

[Human communities beyond Earth’s cradling biosphere]

By Peter Kokh

This month we look at how future Lunan Architects will be challenged by the conditions of their environment, with full attention to structural integrity under pressurization stress and to shielding from cosmic rays and solar flares.

To illustrate the possibilities, three articles follow: SKYSCRAPERS?, MOON ROOFS, and SHANTYTOWN.



Perhaps you’ve seen artistic visions of future Lunar and Martian cities replete with modern skyscrapers and flying roadways, all under protective domes of glass or some superior glass-substitute. We touched on this distant possibility in both of the last two issues. Certainly there is much more room for creative license on the part of architects working *within* the protected “middoor” volumes of megastructures like domes, and shielding vaults such as that illustrated in the Prinztown design study [see MMM #s 26-31, esp. # 29 p.4].

But looking at possibilities in the nearer term, when pressurized structures will be individually shielded, we might ask if Lunar and Martian xitiscapes can escape the mole mold of mound rows of shielding soil, hiding cramped lifespaces below. The appearance of this shielding overburden is our topic in the piece that follows: MOON ROOFS. Here let’s explore how architectural ingenuity can help a thriving Lunar or Martian settlement break out of the terrain-hugging rut.

Traditional skyscrapers here on Earth, as varied as they be in style, are basically vertically elongated boxes. Such a shape will not work well if it has to contain atmosphere under pressure against a surrounding vacuum. While higher surface strength to volume ratios allow more freedom with very small

structures, on the greater scale of the multi-story building exo-architects will have little option but to somehow adapt the sphere, cylinder, or torus, all of which do a much better job of equalizing pressurization differential stress. There is, to illustrate, no reason that a cylinder couldn’t be employed in the upended position, properly anchored, with its internal floors perpendicular to its long axis, instead of parallel to it.

So much for meeting the pressurization challenge. We must still find a way to preserve shielding integrity. A simple outer sleeve a couple of meters (6 ft. or more) out from the cylinder’s pressure hull, creating a wraparound coffer dam for filling with soil, would do the trick. But that certainly does not present the architect with a satisfying form of statement. The whole idea of multi-storied buildings is not merely to create an imposing silhouette against the sky, nor to make efficient use of high cost real estate, but also to allow visual access to the ambient outdoors sun/daylight and to the views generous window-wallings can provide.

If you accept that such structures on the Moon and Mars would be occupied only part time by office-workers, for example, and if you restrict the field of unshielded vision to “a couple of *horizon-hugging* degrees” or so, vertically tunnel-visioning the view of anyone wanting to look out, the total averaged exposure to cosmic radiation from unshielded sky could be kept to an acceptable minimum, even on a long-term basis. If the simple illustration below reminds you a bit of the oriental pagoda with its tiered “pentroofs”, that is no accident, for that is the source of the inspiration.

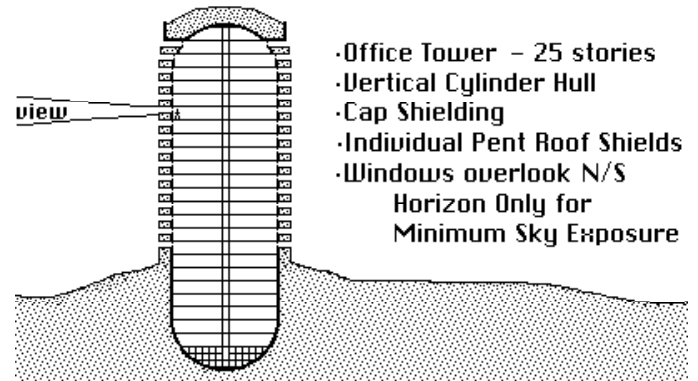

- Office Tower – 25 stories
- Vertical Cylinder Hull
- Cap Shielding
- Individual Pent Roof Shields
- Windows overlook N/S Horizon Only for Minimum Sky Exposure

What appears to be balconies in this sketch, are really continuous cantilevered coffer dams filled with loose regolith soil shielding. Building occupants are restricted to the interior of the fixed pressure-holding windows to the inside of these “pent roofs”.

This gives us an architectural “language” that can be used in yet more expressive forms. Below we have a vertically stretched torus “muff” surrounding a central cylindrical tower.

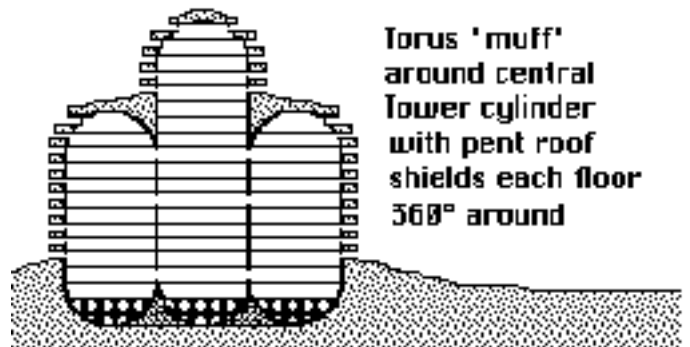

Torus ‘muff’ around central Tower cylinder with pent roof shields each floor 360° around

The inner and outer walls of the stretched torus would have to be constrained to shape by floor-incorporated cables under tension.

Another possibility may be to stack (co-axially, or perhaps stylishly off-center) story-thick sections of cylinders of decreasing diameter, each with an attached pent roof soil bin to shield observers inside from the greater portion of the naked light-black, radiation-bright sky above.

The wider the diameter of each story section in proportion to its height, the greater the need to keep floor and ceiling in parallel, not by support pillars under compression, but by vertical (faux column hidden) restraint cables under tension. For unfortunately, the weight of the soil overburden sufficient to provide the needed amount of radiation shielding, is no match in the light lunar gravity (“sixthweight”) for the expansive pressure of the “atmospherule” below against the vacuum outside. On Mars where the gravity is two and a quarter times greater, the same amount of shielding soil mass will exert that much more of a stress-relieving counterpressure on the building “hull”.

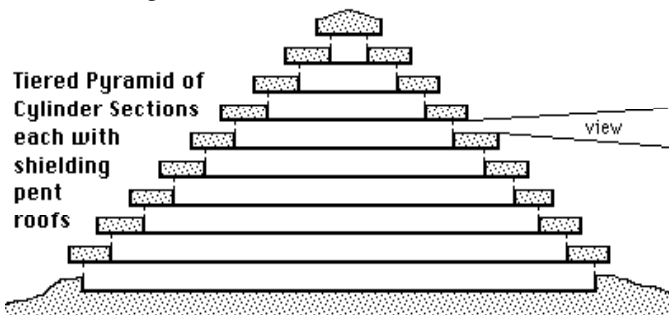

A less pretentious example of sky-scraping is given in the end-view cross-section sketch below, where a number of horizontally placed cylindrical pressure hulls are stacked. The advantage is in longer rectangular floor space.

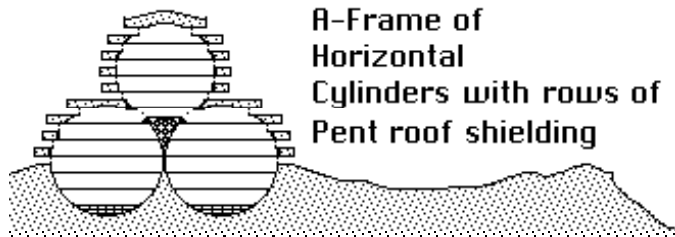

By whatever structural idiom it is stated, just as in some terrestrial cities, the skyscraper can be given even greater visual impact by siting it on high ground relative to the general surroundings (like the famed Shangri-la inspiring 2500-roomed Potala palace in the center of Lhasa, Tibet) e.g. on a crater wall or central peak, a scarp or lava flow front, etc.

And, of course, purely decorative unpressurized doodads such as spires and minarets or other façade-making hull-disguising decor can be added for tasteless kitsch allusion to one or more of the many Earth-legitimate building styles of past and present. We can only trust that most future Lunan and Martian architects will see the value of learning to express themselves in authentic world-appropriate forms. But it *is* a free universe!

Perhaps you can think of further distinctive directions in which future settlement architects can give vent to their vertical aspirations. If so, we hope you will send them in to

MMM so we can share them with our readers.

But, is there a need? Will lunar settlements ever grow big enough for the real estate at their cores to become valuable enough to justify the extra expense of high rise construction? Certainly not if they are or remain government artifacts. But if settlement is enterprise driven, first supplying raw materials, then value added products, exploiting every advantage, and diversifying its own domestic economy, there is no reason why the number of pioneers on the Moon cannot rise into the hundreds of thousands or more within a half century of their founding. Remember, for a largely self-sufficient economy, the export sales needed to cover import costs will be relatively small. In the context of a rapidly diversifying economy, in comparison to the rise in exports, the growth of the supported population can be exponential (e.g. a 10-fold rise in exports for a 100-fold rise in population).

The rise of settlement “downtowns” and of metropolitan and regional market centers should be expected if we are to have a real expansion of the human economy through off-planet resources, i.e. a spacefaring civilization. In this setting, the appearance of skyscrapers within or without enveloping xity megastructures should not be surprising.

But settlement skyscrapers should also not be seen as a foregone conclusion. While they might be considered for hotels, offices and corporate headquarters, residential condominiums, government buildings and so on, for each of these needs there are plenty of ground-hugging horizontal models. Indeed, if there has been adequate xity planning, the need for Manhattan style density should never arise. What multi-story buildings are built may be very modest by Earth standards.

Rather than “scrape the sky”, lunar multi-story buildings will “break the horizon”.

Indeed there will likely be operative on the Moon a strong DISincentive to dense high-rise building: the neighbor’s right to unshaded access to the Sun’s valuable rays. This may mean that multi-story buildings must have proportionally great east and west setbacks, so that they do not rise above a certain rather low angle above the horizon, say 10°, at the property line. In such a situation, the vertical high rise is no longer an efficient use of real estate. (In theory, the best solution would be a very, very shallow broad-terraced pyramid.) The view (for residents or occupants) and the image (for customers and clients) then, may well turn out to be much more important drivers than the efficient use of “footprint”.

Terrestrial suburban office parks that have become common in the past decade, offer a more realistic inspiration for lunar high rise developers. Rather than “scrape the sky”, their constructs will break the horizon. Nonetheless, they will shatter forever the image of lunar towns as “mole hill city”.

Visitors to a lunar metropolis will ride “middoor” coaches plying the xity’s pressurized avenues within the shared biosphere. But they will also peer out over the surface xity-scape from shielded overlooks within the various high rises, and get a good outside perspective from the pressurized out-vac coach to and from the spaceport. Finally, in 1/6 G, a space needle observation tower could easily be a mile high! **MMM**

MOON ROOFS

Roofs on the Moon? - where it never rains or snows? Ah, but it does rain - a gentle slow micrometeorite mist, *and* a steady shower of cosmic rays, *plus* sudden 'cats and dogs' outbursts during solar flare episodes. While the characteristically imbricated (tile or shingle overlap) shedding features of terrestrial roofs would not be called for, the sheltering function of the 2-4 meters (6+ -13 feet) of shielding overburden above Lunar or Martian habitat space will be more than a little analogous to the familiar roof, a prehistoric heritage.

To the architect, the roof has traditionally been one of the most important opportunities for statement of style. To give some outstanding examples: the thatched English cottage, the terra cotta Spanish Tile roofs of the University of Colorado in Boulder, the green-patina copper roofs of many early urban skyscrapers, the onion domes of St. Basil's in Moscow's Red Square, the tailored French mansard, and the Pagoda.

It would be natural for future settlement architects in the employ of well-to-do façade conscious homeowners to turn to the shielding blanket as a clay for expression. And for those hired by companies seeking a striking design for their new headquarters building, to turn to lunar "roofs", alias shielding, as a medium of style.

Already, purely for the utilitarian reason of simple convenience, some outpost designers are specifying that their habitats be neatly sand-bagged. The advantage of placing the loose lunar regolith in bags should be obvious. Not only will it keep the construction site cleaner - and safer (from dangerous bull-dozer module collisions) - it will allow the bag-tamed shielding to be easily removed in order to repair hull and joint leaks, to make structural modifications, and to exchange old, or attach new, expansion modules. Meanwhile, by this simple trick of bagging, the external appearance of the outpost is drastically altered. The 'lith-bagged' outpost now looks like an on-surface installation rather than an under-surface one, its appearance and presence radically transformed.

An alternative to the bag or sack (which could be made on site from medium-performance lunar fiberglass fabric) would be sinter blocks made from compacted and lightly microwave-fused soil. By varying the size and shape of such blocks and the patterns in which they are stacked, distinctive igloo-like styles should be easily achieved.

Grecian Formula

It does not stop here. There is no cosmic law that states lunar shielding must be gray, or Martian shielding rust-hued. If desired, colorants can be added to the material itself, or glazed or even merely dusted on an exposed, rough surface.

In the early settlement, the availability of colorizers will not be great. On the Moon, Calcium Oxide, CaO, i.e. lime, made from highland soil will be a likely early favorite, probably cheaper than mare ilmenite-derived Titanium Dioxide, TiO, also white. Either way, "whitewashing" Lunar settlement shielding mounds might early on become "politically correct",

for they would make the settlement a conspicuous very bright spot on the Moon's surface, perhaps even outshining the crater Aristarchus. This would make Earthlubbers more conscious, and hopefully supportive, of their frontier-blazing brethren above - a cheap way to put any Moon town in the "limelight"!

More than empty vanity

By the simple addition of shaping or sculpting or colorizing, the shielding mound will become more than a visual disturbance of the surface. The 'lithscaper's or architect's touch can imbue the protective mound with design, *unearthing* the presence of the living and work space below and making the otherwise hidden structure visually present above the landscape in an identifiable, pride-investing way.

This transformed self-image of the settlement may have real positive effects on the outlook, mood, and morale of the pioneers themselves. For it can be an early, easily won battle in a campaign to "humanize" the sterile barren alienness of their surroundings, thus contributing subtly to a sense of being "at home" in their adopted raw new world.

Economic opportunities

Indeed, outside of the occasional observation cupola, for most surface settlement habitat architects, the "roof" may be the principal opportunity for exterior public-side statement (other than any openings to also shielded public "middoor" spaces like pressurized roadways, passageways or squares etc.) But the opportunities for "roof"-styling will more than reward frontier architects. This market will also provide entrepreneurial openings for enterprising settlers to develop the additives, the tools, the equipment, the processes, for making such on-paper possibilities real off-the-shelf choices.

Bower Roofing

Nor need 'roof adornment' be an expensive luxury item. For it could also serve as an at least temporary 'banking' outlet for otherwise hard to recycle used building materials and other non-organic 'debris' - perhaps in shredded or gravelized form - and for various orphaned manufacturing and mining byproducts for which more suitable uses are not yet in sight. These are two stubborn categories which contribute significantly to terrestrial landfills, yet receive little if any attention. Here we could take a page from the bowerbirds (8 species in Australia, 8 in New Guinea) who decorate the interiors and entrances of their nests with "found" objects of all sorts.

Settlement Signatures

Without attention to shielding style, it could well become a prevailing truism that once you've seen one surface frontier town, you will've seen them all. Given human nature and the slightest modicum of discretionary private and public funds, it is unlikely that such will be the case.

Distinctive 'lithscaping and "roofing" styles may become characteristic identifying trademarks, not only of individual structures, but of different lunar and Martian towns taken as a whole. *And there will be economic incentive*, and payback, for the small expense involved in the form of tourist interest in "local flavor". Long before any Lunar or Martian towns become large enough to begin to grow small high-rise "downtowns", they may become identified in the tourist mind by their individual mix of "roofing" styles. And all it will really take is a wee bit of imagination!

MMFL

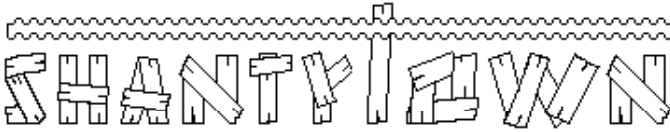

We opened this issue with an IN FOCUS discussion of a current brash proposal to unilaterally open the Moon, or a large part of it, to homesteading. In all honesty, only space within a biosphere can be ripe for homesteading. In that sense, except for the obscenely wealthy, homesteading will not be an early way to open the space frontier. Some territory that is to be *made* "homestead-friendly" must be opened first.

Nonetheless, there will be at least temporary imbalances in the supply and demand for private residential turf on the frontier. Like it or not, there will be displaced persons, hard pressed to use their ingenuity to hustle up secured privacy (if not shelter) - within a constructed and maintained biosphere - using "found" cheap, if not free, discarded materials or by-products. There will be no outside ("out-vac") shantytowns hugging settlement walls. But there may well be cyclical or even persistent economic dislocation and quarterslessness within the containing biospheres of the Lunar or Martian towns and their early boom-bust economies.

To hide from this eventuality like an ostrich is not appropriate planning behavior. Rather, recognizing that this unfortunate sideshow of what we like to think of as mainstream human life might well follow us out into our new adopted extra-terrestrial homelands, we ought to plan a gamut of strategies to deal with it. Barracks and dormitory space for newcomers, singles, estranged mates, and the elderly unwanted must be provided. The pace of public works outside the settlement, i.e. building new roads, outposts, supporting science excursions can all be speed up or slowed down as this labor pool grows or shrinks.

This said, there will still be those - hopefully only a few - who will be without proper personal quarters. But their numbers could rise in bad times faster than the public sector can make provision or adjustment for them. Within-the-walls temporary shantytown areas could be provided on an emergency basis to take up the slack.

Shantystuffs on the Space Frontier

As with shantytowns on Earth, the building materials of choice will be those that are free for the taking. Discarded skids and crates and tankage and other packing and packaging materials stockpiled for eventual recycling could be drawn down for this purpose. Indeed it might take little in the way of cost or effort to manufacture such materials in the first place with an eye to this potential reassignment or diversion of use, making them shanty-friendly so to speak.

Many items will be co-shipped as "packaging" to the Moon with the expense debited to the C.O.D. cost of the packed items. The idea of choosing, manufacturing, designing and/or processing such "packmates" so that they are capable of diverse reuse, is one we have mentioned before. For example, we could choose to ship things in copper, lead, or other strategic "lunar deficient" metals that can be cannibalized latter. We could choose to formulate packaging materials out of low molecular weight solid hydrocarbons that can serve as chemical feed-stocks, or out of compostable molded materials rich in

the micro-nutrients that lunar soil typically lacks, etc.

Manufacturing common shipping "tare" items so that they can also serve as easy-to-assemble shelter components, shouldn't be difficult. This process of adding extra features to make unrelated reuse simpler, easier, and cheaper is called "scarring". Given the hidden exorbitant cost of importing such co-shipments, it'd be foolish not to invest the relatively minor cost of scarring them to leverage the bootstrapping of the settlement economy. And when and if the need for "make-do" temporary housing disappears, these items could either be recycled or made available to entrepreneurs who can transform them into elements for durable and attractive housing.

Deliberate shantytowns and worse cases

While we might hope that the need for all this proves to be minimal, it is on the contrary possible that some space frontier settlements, in the asteroids for example, may even be designed totally as shantytowns through and through. They would be set up to serve some temporary purpose, then fold up gypsy style, to be set up afresh in some new location.

Other space frontier towns, confidently designed and constructed as "permanent", may suddenly find that the economic underpinnings of their survival have vanished through an evolution or revolution in technology perhaps, or through the opening of cheaper alternative sources of whatever they supply to the off-planet economy. If such a town has not moved early to diversify its exports, all or most of its inhabitants might suddenly become displaced. Without any alternate ways to hold on in "depression mode" until recovery measures can be realized, the need to shanty these people elsewhere may become urgent.

Differences from Earth

Hopefully, the minimal intra-biosphere shantytowns that do arise will not be totally dismal places. Even in the worst favellas surrounding our exploding third world mega-cities, it is possible to find pockets of art, design, and obvious pride of place. For it is not the materials that are used, but the care and imagination with which they are used that make such differences. The talents for blending composition, for artful juxtaposition, for cheerful accentuation with color, etc. etc. - these are talents that are rare. But they are also free.

Given likely high standards for settler recruits, these talents may be less uncommon on the space frontier. Shantytowns that arise out there, might prove welcome exceptions, exuding hope and promise, rather than despair and resignation.

Space Frontier communities will not be utopias - not in any social sense (despite careful preplanning for special challenges) nor in any materialistic sense. It will be a long, long time before life on the Moon, Mars, the asteroids, or in free space oases will be as sophisticated or genteel as in most any city on Earth. This frontier, like all those that have come along before, will be for those who thrive on the rough edges and cheerfully rise to the challenge of softening those edges, rather than those who need to find them already velvetized. And when this frontier opens, those who value luxury, refinement, and being up to date or ahead of the Joneses, will do best to stay behind on Earth. Space will be an opportunity to tame and create and overcome and contribute and sew, not soon an escape for those who would only reap and consume. **FRANK**

AGRI-GARMENTS

by Michael Thomas, Seattle L5 Society

It is often assumed that due to the lack of hydrocarbon rich raw materials like petroleum and coal on the Moon, lunar inhabitants will be dressed in natural fabrics, particularly cotton. But this poses several problems, particularly for early lunar settlers. One is that there is little or no data on the feasibility of growing cotton hydroponically and early outposts will almost inevitably use hydroponic methods of food production. Another is that a large fraction of the cotton plant is inedible and otherwise useless. So only the cotton fibers themselves would be in demand. Early CELSS environments will probably not be able to afford such wasteful agricultural choices.

Even food crops will likely have to be modified for CELSS agriculture. NASA researchers are already attempting to modify rice plants with genetic engineering so that they will provide more complete nutrition. Natural rice protein is deficient in some amino acids essential to human nutrition, but genetic engineering should be able to correct these deficiencies. A further goal of this research is to develop rice plants whose stems and leafy blades are tender and edible, so that very little of the plant is nutritionally useless.

In related work, other researchers are pursuing similar goals, such as the development of a strain of corn in which the cob is tender, juicy, and edible, as well as the kernels. Such will likely be the fare of off-world hydroponic gardens, and this leaves little room for wasteful cotton production.

A further complication is the relatively complex and labor intensive process of milling cotton from raw bolls into thread, fabrics and clothing. There are several steps involved from harvesting to the gin to spinning threads and weaving fabrics, to the design, cutting and sewing of those fabrics into garments. Whether a robotic textile mill is designed, or one employs human labor, a good deal of machinery and energy are required to perform all of these steps. It is too complex and unwieldy.

So what is one to wear? Paper? It has been said that paper will be so costly in space habitats that books and other hard-copy documents will be rare and expensive. This may be correct, but I submit that cotton fabrics will be considerably more costly to produce.

paper: a *non-woven* substance made from rags, wood, or other fibrous material, usually in thin sheets, to bear writing or printing or for wrapping things, decorating walls, etc.

fabric: a cloth made by *weaving*, *knitting*, or *felting* fibers.

And we must not allow ourselves to be trapped into conventional thinking. Paper can be made of many different kinds of plant fibers. In fact, wood pulp paper is a very poor source for garment-grade papers. It is too hard, inflexible and it tears easily.

A fraction of such paper can come from plant root, stem and leaf fibers, but the bulk of such paper should have to consist of longer, stronger and more flexible fibers. There are several possible sources for such fibers. One is cotton fibers. Yes, I have spent paragraphs arguing against the use of cotton textiles, but I am speaking of much smaller quantities here and

far simpler processing. A paper garment need not contain more than 10% cotton, as opposed to 100% for an all cotton garment.

And there are other possibilities that might be more economical than the use of cotton. In a CELSS environment. If any animals are raised for food or as pets, such as rabbits or cats, sheared fur could be used as reinforcing fibers in paper. Even human hair could serve this function.

Along other lines, researchers working for the D.O.D. have genetically engineered bacteria to produce spider silk. This silk is to be used in the production of bullet proof vests and flak jackets superior to those made of Dupont Kevlar™ today. This sort of fiber would be ideal for reinforcing and softening a paper made partially of vegetable fibers.

Even cotton fibers have recently been grown in a petri dish for the first time, without the wasteful bulk of roots and stems. It would likely also be possible for bacteria to produce cotton fibers, and long, cotton-like cellulose fibers to make a unique paper that is smooth, soft and flexibly strong like no other before: perfectly suited for making comfortable and reasonably durable garments.

Relatively primitive paper production methods would be easy to automate to a large degree, and garment production could be simple and standardized with a few styles to choose from. And since color fastness would not be required, relatively primitive plant dyes could be used in a form like water colors, to paint designs or artwork on garments. In fact garment painting could become a hobby or folk-art in which individuals are encouraged to participate and so express themselves creatively.

The paper itself could be made in various solid colors. Since bleaching by conventional chemical methods would be unthinkable, the base color of the paper might be some sort of off-white or manila color, depending on its exact contents. However, ultraviolet radiation might be of some utility as a bleaching method if white were desired in garments for special purposes or occasions.

On Earth, paper garments have been worn in Japan for centuries, and have enjoyed a couple of periods of brief and limited popularity in the west. I recall paper dresses being a fad in the sixties. More recently, paper jackets have been seen. Yet far more appropriate garment papers than those presently in use could be produced using exotic materials. Papers have been made with synthetic polyester fibers for clothing, shipping envelopes and other special uses.

But the possible range of unique papers made of many fibers for many uses is almost limitless and has been poorly explored at best. There is lots of room for work in this area, and it is possible that with fibers like animal hair, cotton and spider silk, papers could be made durable enough to survive several cycles of washing and wearing before wearing thin. (Most currencies are printed on such durable papers already, though garments would have to be considerably softer than dollar bills.)

In addition to clothing, various grades of paper could replace other fabric items such as bed sheets, canvas for paintings, draperies, table cloths, wall and furniture coverings, even shower curtains. <MT>

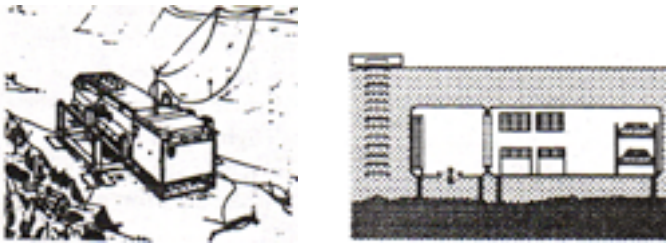

Mimicking the Vacuum of Space with the Wet of Water

As air-breathing creatures, water is a barrier to us, though one which we have learned to negotiate. We're now in the process of learning to cope with the barrier of vacuum as well. The containment hulls we need in both milieus are similar enough that we can do much early Space Research & Development in underwater labs.

LEFT: NOAA's Aquarius habitat.

RIGHT: wet porch for access.

MORE: => "Quarantine" (by water) below.

Continuing with our series on



Pronounced KSIH-tees, not EX-ih-tees

[Human communities beyond Earth's cradling biosphere]

By Peter Kokh

This month we look at how xities, unjoined by a common biosphere, react with the quarantining medium around them, be it the vacuum of space, sterile lunar, asteroidal, or Martian soils, or unbreathable atmospheres.

The first essay, **HARBOR & TOWN**, discusses the xity as a port, how some xities will fit that description more transformingly than others, and how the port function will govern their material and cultural development.

The second piece, **NAMING The SEAS Of SPACE**, discusses the differences between vacuum here, and vacuum there. It is not just the surfaces of celestial bodies that differ! And these differences will very much affect the xities involved.

The third article, **QUARANTINE**, discusses the value of water, on Earth, as a model of the vacuum of space or as a model of unbreathable atmospheres, that can be useful for much of the preparatory research and development tasks we need to undertake before we are truly prepared to build xities beyond our cradle biosphere, whether they are built in free space itself, or constructed on hostile and barren lunar, asteroidal, or planetary surfaces.

Harbor & Town

Anyone who has read science fiction stories about the Moon or Mars has come across names like Port Roris, Port Heinlein, Port Lowell, Marsport, etcetera. It seems a natural way to name a space frontier town. Indeed, won't every such burg be a port? Not really! In the first "beachhead phase" of settlement, we are likely to use vehicles like the Apollo era Lunar Excursion Module that could *self-land, self-unload, and self-launch* - no (space)port facilities needed, thank you!

But this sort of clean operation, efficient and necessary in opening virgin territory, also limits operations. Sooner or later the outpost/settlement-to-be will initiate genuine port functions. There'll be repair shops, fuel depots, landing beacons and paved pads, even smoothways for craft touching down with a residual horizontal velocity. There will be mobile cranes and specialized gantries. Trouble-shooters will service engines and doctor ailing CELSS air and water recycling systems. And a genuine space port will have been born.

To avoid expensive duplication, other outposts and towns that can be provisioned overland or by suborbital hoppers may chose not to develop full port facilities. They will have their self-service landing pads and smoothways, of course and they may see the occasional self-unloading freighter or chartered tourist craft, but nothing like the frequent, even scheduled cargo and passenger service of the "central" or "regional" spaceport. And this difference will translate into settlement lifestyles and cultures that are radically distinctive.

In contrast, one almost never hears the word "port" as part of the name of some fictional space settlement or O'Neill colony. Perhaps that is because the word naturally connotes to us the existence of some corresponding "hinterland" which the port serves. And our vision of space oases has been that each is a self-sufficient island unto itself.

How realistic is that? While each space settlement must have docking facilities, sooner or later one will offer special "port facilities" that will attract more traffic, making it a hub from which others are served by secondary craft. Indeed it seems to us more logical that one major spaceport or yard will emerge in the L5 co-orbital field, another at L4, and that a growing percentage of traffic will converge at these facilities, with cargo and passengers increasingly transshipped by barge and shuttle to "hinterspace" settlements.

If full service spaceports emerge on the frontier, what will they offer? In addition to the facilities and services already mentioned, port xity contractors will overhaul, rebuild, re-outfit, and reconfigure aging spacecraft and their systems. There will be a "junkyard" or salvage dealer, maybe even a graveyard for obsolete craft (a museum in the making!) There will be warehousing for incoming and outgoing backlog buffers of cargo. There will be tank farms for liquid and gaseous volatile storage and chemical feedstocks. There will be a

fuel depot for the many kinds of fuel likely to be used: liquid Hydrogen and Oxygen, Methane and Ammonia and Silane. There will be hoppers of powdered fuel: Iron and Aluminum and their enhanced performance powdered alloys. There will be containerized unloading and transshipment facilities.

In the nearby town will be the ship chandlers: dealers in ship supplies and equipment. Exporters of heavy equipment will find an advantage in a port city manufacturing site. The bigger transshipment firms will headquarter here. Chemical, engineering, biospherics and electronics laboratories will sprout up to serve the growing list of port service contractors.

But the port town will also see the rise of import-export banks and trading houses, of "marine" insurance firms and trade law lawyers. Stock markets and futures markets could arise. Wholesalers will cater to the distribution market, fostering hinterland growth and that of the port city with it.

Port cities may vie to become the "homeports" of various ships and whole merchant fleets. A sort of "Hanseatic League" of the major port cities in the Inner Solar System might arise to promote free trade, and regulations in their common interest, perhaps even footing the bill for a policing agency to counter piracy and hijacking. Such an alliance could be a forerunner of a loose System-wide political federation.

Port cities will tend to be socially and legally rather liberal in their mores, and noticeably more cosmopolitan in their ethnic and cultural diversity. In contrast, town founders wishing to try some great social experiment are likely to pick settlement sites off the beaten trade track.

Goods, both import and export, will be transshipped to and from the regional spaceport and hinterland or hinterspace communities. Much of this traffic will be containerized, using space barges, overland truck trains, and suborbital hoppers or slide landers, as the case may warrant. Passengers will travel to and from the spaceport city by feeder surface coaches and suborbital craft or space-to-space shuttle taxis. Material novelties and cultural innovation will ripple outward from the space port centers to dependent outlying settlements.

Detachable holds of speculative trade vessels making circuit rounds between various settlements might be designed "snugline" fashion to slip into special airlocks and taxied or tugged to an in-city market berth where they could unfold for business, self-contained import shops ready-to-go. Resident hawking agents would vie for the business of visiting trader ships not so equipped to do their own marketing. These trader craft or "circuiters" would work to increase the amount of trade, thereby helping diversify the art-craft and manufacturing base of each city on their routes. As a result, an ever greater percentage of frontier settlement economies would be involved with mutual trade as opposed to trade with the home planet. And an ever greater portion of that trade might be speculative rather than based on direct customer order.

This trade will be in specialty foods and delicacies, in special fibers and designer apparel, in chemical and organic feedstocks, in strategic raw materials and locally deficient volatiles, in furnishings and arts and craft accessories and gifts. An emporium, for the latest usually unavailable goods hot off the "traders", may determine by lottery who'll have a privilege to purchase items too few to match the demand. There will be

barter and haggling. Dealers and galleries will take some speculatively imported art and craft items on consignment. Recognizable spacecraft parts may become fad "canvas" pieces for port artisans, much as old saws for country painters.

There may be trade in salvaged ship decor pieces and "architecturals" in demand by restaurants and hotels to provide space-maritime "atmosphere", or sought by individuals for their dens. Decommissioned spacecraft could find themselves resurrected as visitor centers, nightclubs, and roadside motels.

And what about visiting spacecraft personnel, the spacers and spacehands of lore? The port city might offer more spacious and comfortable quarters in which to enjoy their liberty or "shore leave". There will be catering chapels and counselors, recreation clubs and sports facilities, and fast track intensive schooling. There will be medical clinics to treat postponed problems, and specially scheduled seminars to help them catch up on the latest technology in their field. The port will also be a place to receive waiting non-electronic mail.

Married spacehands may keep their families in the port city, their children in its schools. The Moon and space settlements offering lunar standard 1/6th gravity will be the favored homeports for spacefarers, for the adjustment to and from zero-gravity will be much easier. Spacecraft providing artificial gravity are far likelier to offer the lower lunar standard as it is much less structurally taxing, and means either slower rates of rotation, a shorter radius or both. Few spacefarers will call Earth home, or even Mars. "Sixthweight" rules! For the same reason, spacer guilds and guild halls are likely to be quartered in sixthweight ports. Here too will be the favored communal resting places for spacehands who do not prefer consignment of their remains to the so lonely depths of space.

And for the legally or behaviorally footloose there will be the usual spacefront dives and flophouses and dance halls: places where they can get quick fixes of whatever they found themselves lacking on the long journeys between ports. And there'll be unscrupulous town merchants seeking to trade worthless baubles for shore wages. Tattoo parlors? why not! But also prisons and briggs where needed.

Which brings us to the subject of salutary outlets for people who don't find themselves fitting in. The port city will be a place for tired spacefolk to settle down. And the roster vacancies aboard visiting craft will be a siren for the town's restless. The port town's young will be drawn to the spaceport to watch the incoming and outgoing traffic, feeding their wanderlust. It is from their ranks preferentially, as opposed to the young of hinterland and hinterspace frontier towns and outposts, that the next wave of volunteer settlers will come when some new world or worldlet is about to be opened.

Yet this dose of reality for would-be surface ports on the Moon and Mars! Increasingly, larger spacecraft, including all those using fixed booms rather than winchable tethers to provide artificial gravity in cruise mode, will be forever confined to space, unable to make planetfall. Only zero-G space craft and shuttles will come down to the surface, plus the unique class of smaller circuit-making trader ships that are designed to separate in space into winch-tethered components for spin-up to sixthweight mode. [See the description of the aerobrake Earth-Moon ferry "Jules Verne" in "Lunar Over-

flight TOURS” in MMM # 21, Dec ‘88, MMM Classics #3.]

If this is so, then *THE* lunar spaceport may be a space depot in low-lunar-orbit, “LLO”. Here the large fixed-configuration cargo and passenger ships will dock, their wares taken down or brought up by “lighters”, passengers by shuttle taxis. Here in the environs of “Port Lunagate” will be the big ship-yards for big craft and their even larger successors. *But, if* this is only a transfer hub and not a population center, as seems the likelier eventuality (to this incorrigible planetary chauvinist) then the surface port cities that it serves will still hoard the bulk of the port-typical features discussed above.

Still, even if the really big ships never swoop down out of the starry lunar skies, the comings and goings of smaller craft will be the talk of the town. Reporters will interview inveterate old spacers, thirsty for the latest yarns. Newspapers will advertise the sudden manna of trader-brought goods. Restaurants will advertise the sudden availability of rare delicacies and savory delights. The port’s bars will be enlivened by the company of the visiting spacefarers. Art and literature in the town will mirror this opening to the larger world. And among all the settlements on the frontier, those that are port cities will be the liveliest, most colorful, most memorable.

Yet for every Yin there must be a Yang. There will always be those who prefer the quieter, more relaxed, less quick-changing “best kept secrets” of hinterland and hinter-space towns in which to live, and raise their families.

NAMING THE SEAS OF SPACE

Vacuum is vacuum, right? Okay, but only in the sense that water is water! Admit the differences between salt water and fresh, between sheltered harbor waters within the breakwater and the untamed waves and currents beyond, between shallow coastal waters and deep open waters, between waters with strong currents and the brackish waters of ever-circling eddies, between crystal clear waters and sediment-laden and debris-filled waters - admit that and very similar differences must be granted descriptive of the vacuum of space.

Space does have its special “seas”, and the differences between them are far more than a simple matter of “location” alone. The idea of naming them thus takes on a much greater significance than one of simple convenience or local color.

Traveling outward from Earth’s surface, we first encounter that boundary layer space in which, if you want to be technical, there are still wispy traces of the atmospheric gases below. Here, in the range of low Earth orbits, in LEO, we are on the calm lee side of a “breakwater” (“breakspace”?) of sorts. For the energetic Van Allen Belts trap and divert most of the magnetically charged particles traveling through space, coming

principally from the Solar Wind blowing constantly off the surface of the Sun, but also including charged particles coming in from interstellar space, cosmic rays.

This “fresh-vacuum” “lee-space” of the “**Terrestrial Lagoon**” can be recreated on the Moon by erection of work and construction site sheltering canopies, or “ramadas”, under which radiation-damping “hardsuits” needn’t be worn. Lighter “pressure suits” will do. But within and beyond the Earth-life protecting Van Allen belts, our ships will need “windbreakers” of sorts, especially if we are going to linger in these radiation-swept reaches for any appreciable length of time.

Meanwhile, we should have noticed that while Earth’s coastal vacuum is relatively “unsalted” with radiation, it has also become increasingly dirty with dust and debris derived from unnecessarily sloppy and careless human activities. This **LEO Sargasso** could have parallels, if we don’t clean up our act, in Earth-Moon **L4 and L5 Sargassoes**, areas where dust and debris will tend to collect and hang around. The other Earth-Moon Lagrange points are less stable and will tend to purge themselves more quickly. The corresponding Earth-Sun L4 and L5 areas centering 60° preceding and trailing Earth in its orbit around the Sun, could already be Earth-Sun Sargasso seas in space. But out here that would be a plus, *if* the denizen “plankton” of those “circling currents” are asteroidal chunks and snuffed cometary hulks of mine-worthy size.

The surface-lapping vacuum above the Moon, while it offers no protection from raw solar ultraviolet, cosmic rays, and solar flares, is nonetheless uniquely clean of dust, any particles with less than orbital speed being quickly purged by the lunar gravity. While only a sixth as strong as Earth’s, the Moon’s pull operates without the interference of atmosphere. This “**Littoral Vacuum**” will be of great usefulness to vacuum-dependent industry and scientific research.

Moving inward towards the Sun from the orbital range of the Earth-Moon system, inward from our native eco-range, we’ll notice as we approach the orbit of Venus, and even more so as we encroach upon the haunts of Mercury, two things. First, the tenuous “Solar Wind” is significantly less tenuous and more blustery by a factor of 2:1 near Venus, and by more than 6:1 near Mercury, increasing with the inverse square of the distance from the Sun. This won’t be a practical problem really. On naked-surfaced Mercury, neutral particles of the solar gale might have created even more of a soil-trapped endowment of useful volatiles than is the established case on the Moon: Carbon, Nitrogen, and the noble gases Helium 4 and 3, Argon, Krypton, and Xenon.

But growing correspondingly more dangerous, again with the inverse square of the distance from the Sun, will be the potential exposure to intermittent and seasonal Solar Flare radiation flood-bursts, deadly storms for the unsheltered.

Second, as we travel inward we’ll notice that, vacuum or not, space is brighter and brighter. Whatever the temperature of space itself, Sun-facing surfaces grow hotter and are harder to cool - again the problems increase with the inverse square of the distance out. The plus side is that solar energy collection becomes correlatively easier and more efficient. And Sun-powered lasers for propulsion, communication, or energy relay become more feasible and attractive. As we travel Sunwards,

we are heading deeper and deeper into brighter, hotter, windier, and stormier space: the **“Solar Maelstrom”**.

On the other hand, as we go outwards from the orbital range of our Earth-Moon bi-planet, the opposite is true. Space becomes less windy and less stormy *but also* colder and darker, again with the inverse square of the distance out from the Sun. At the mean range of Mars and its moonlets Phobos and Deimos, we will need twice as much solar collector surface to gather in the same amount of energy available in the vicinity of Earth and Moon. At the distance of Ceres, queen of the asteroids, collectors will have to be seven times as large to do a given job. And out by Jupiter and the Galilean moons, twenty seven times as large. Ultimately solar power becomes an impractical proposition. We are heading into what we might call the (Solar) **“Twilight Sea”**.

Out around the great gas giants of Jupiter, Saturn, Uranus, and Neptune, it will be difficult to operate human-crewed ships within the powerful magnetospheres around these planets, giant versions of our own **“Van Allen Bay”**, which is deadly enough to those taking too long to transit it. The **“Bay of Jupiter”** will be particularly treacherous, possibly confining human exploration and eventual settlement to Callisto and beyond, putting great frozen Ganymede, ice-lidded ocean-girt Europa, and pizza-hued volcanic Io forever beyond the encroachment of human history, and keeping us from ever plying the relatively placid **“Jovian Lagoon”** at the center.

Hopefully, the **“Bay of Uranus”** will be negotiable enough to allow us to “mine” the abundant Helium-3 reserves in Uranus’ atmosphere, thousands of times more vast than the “pump-priming” deposits on the Moon’s surface, and quite possibly *THE* greatest economic resource in the outer system.

Within the Solar System, and to an unknown reach beyond Neptune, the Solar Wind will act to purge the vacuum of volatile dumpings and “pollutants” carrying them out to the “heliopause” where the force and direction of the Solar Wind becomes indistinguishable from the currents of “interstellar” space. We will at last have left the **“Circumsolar Sea”** (comprising both the Solar Maelstrom and the Twilight Seas).

Here between the stars, we will not yet be in truly empty uneventful space. Interstellar dust and gas clouds are scattered here and there, in the **“Disk Sea”**. Even as we get out beyond the “rim” or out above the “plane” of the Milky Way, we will still be in the **“Halo Sea”** for some distance.

So where, finally, is the **“Vacuum of Vacuums”**? Perhaps in the empty bubble-pockets of nothingness hundreds of millions of light years across that balloon between the great filament strands of galactic superclusters. And who in his/her/its right mind would ever want to journey way out there?

To experienced sailors on Earth, sea is not just sea. It matters a lot if one is sailing stormy north Lake Michigan in November, or the treacherous waters between South America’s Cape Horn and Antarctica, or the placid intracoastal waters behind barrier islands, or in the Inland Sea between Nippon and Shikoku. Each body of water has its quirks, its own friendly and not so friendly moments. So it will be in space for veteran spacers. Only “Earthlubbers” and other non-initiates will speak of “Space” as if it was all one and the same thing.

□□□□□

Q U A R A N T I N E

(by water)

The “root truth” of settlements beyond *Earth’s* biosphere, is that they must each provide *their own* in miniature form, substituting hull and pressure walls for gravity as a container for both air and water. It is a corollary of that root truth that “xities” in space or on planetary bodies unblessed with breathable atmospheres will exist in mutual biospheric quarantine from one another, a quarantine enforced by vacuum, and/or sterile surface soils, and/or unsuitable atmospheres.

That quarantine is not absolute - a vehicle docking with one xity will exchange some air, and possibly some water, with it and take that air, and/or water, on to the xity it visits next, where a second partial exchange will occur. But until the frequency of such minor exchanges becomes an accumulatively large factor, in effect there will be real discontinuity between their individual mini-biospheres, a discontinuity enforced by the life-unfriendly surroundings.

While each mini-biosphere within an outpost, settlement, or vehicle consists both of a mini-atmosphere and a mini-hydrosphere, it is the atmospheric portion in which we live and work directly. Water, as vital as it is to our existence, is not something we can breath without artificial gills (a real possibility). To that extent, the isolating and quarantining function of space and/or hostile environment can be mimicked by placing practice or prototype habitats or outposts under water. Thus **water can serve as an inexpensive but effective “vacuum-simulant”**.

For Biosphere II near Oracle, Arizona, expensive and elaborate sealing mechanisms are in place - and not working all that well either! It would be enormously cheaper and easier to police a barrier between mock-up “biosphere” habitats and the surrounding biosphere of Earth, if the experimental habitat or outpost were simply placed under water.

Nor need the water be deep. To make it work, however, two things will be of critical and definitive importance. First, there must be no air-supply hoses to the surface. Air inside the submerged habitat or lab must be recycled in a closed loop. Second, personnel access must be through the water directly, via a “wet porch”, a room connected to the habitat that has an open hole in the floor, with the water kept from rushing inside by matching air pressure.

And as the water need not be deep, we would not need a coastal site for our experimental space habitat or “lunarium”. Any pool, lagoon, lake, or water-filled quarry 20 feet or more deep ought to do just fine. A deep enough indoor pool or tank would serve as well. In cold climate areas, weather exposed waters should be somewhat deeper, so that the highest portion of the submerged facility won’t be encumbered with ice.

The applications should be numerous. Firstly, this would provide us the enforced quarantine within which to test, *much less expensively than in any other setting*, various parts and improvements to experimental **Closed Environment Life Support Systems** (CELSS) and involved research equipment, whether totally chemical, or partially (eventually, mostly)

biologically assisted.

Following up upon and assisting such research, under these same conditions we could practice **lunar or space agriculture**, perhaps in space station or shuttle external tank sized modules. It'd be easy to mimic lunar day/night cycles in such underwater "greenhouses". Some such relatively inexpensive facility would be an obvious asset someday to the work of Lunar National Agricultural Experiment Corporation. LUNAX is endeavoring to work with students in gathering groundwork level data that will help determine the best approaches to lunar agriculture for the era of real settlement - beyond the "salad bar" needs of tiny early outposts.

Progressing further, we could use such facilities to get a better handle on the most workable **biomass to human weight ratios**. Most space enthusiasts, and the artists who cater to their enthusiasm, seem to envision space settlements as basically human habitats with an extra generous amount of houseplants. Even expansive O'Neill colonies are naively pictured to be much like familiar terrestrial "garden suburbs". In reality, settlements beyond Earth will almost certainly have to be basically large farms, each supporting a relatively small village. Vegetation must host people, not people vegetation! Yet that stubborn fact raises both the expense and structural mass thresholds for creating off planet settlements. So it will be very important to ascertain the lowest vegetation to people ratios we can sustain, and that will differ with the kinds of vegetation involved in life support. The results from the first and subsequent runs at Biosphere II are sure to raise some eyebrows. We'll need much more research, and underwater labs can lower the cost considerably.

Yet we will also need chemical CELSS systems - for small space stations, for spaceships, and for lunar surface vehicles. Even in space and lunar settlements, some industrial facilities will need to have separate air and water systems lest their "dirty" outputs overburden the biological recycling systems of the residential, commercial, and light industrial areas of the settlement. Such separately cycling systems can be easily tested and improved in the water-enforced quarantine of submerged laboratory modules.

Test-out of low-G (e.g. lunar) and very-low-G (e.g. asteroidal) mobility-assist equipment could easily be carried out in the same tank, pond, or lake facility, adjacent to the submerged modules. And while the wet porch would provide adequate controlled entrance and exit for both personnel and supplies, such an underwater facility could also be outfitted with a barometric liquid air-lock for containerized provisions, in order to test and debug the associated conveyor system. [See LIQUID AIRLOCKS, MMM # 17, July '88. Available by SASE + 25¢ from MMM Reprints, c/o the LRS P.O. Box].

We greatly need, and need to provide moral support to, the work being done at Biosphere II. But so great is the volume and variety of research that must yet be done to prepare us for space and lunar settlement, and so expensive are above ground facilities like that in Arizona, that it is imperative that we also support such research in water-quarantined complexes.

To date, the various Sealab type projects undertaken by the Cousteau Society, the U.S. Navy, and by the National Undersea Research Program (NOAA's Office of Oceanic and

Atmospheric Research), have not been aimed at the kind of research program we have outlined above. However the physical facilities they have built do provide useful experience.

The first underwater structures to be built specifically to help model "space environments" will be those in various development and planning stages by the League of New Worlds based in Florida. There, work is steadily and encouragingly progressing towards the establishment of mankind's first underwater settlement. "Atlantis" will have a 2000 ton concrete and steel core facility about 25 miles off the coast east of Port St. Lucie in 125 ft. deep Gulf Stream waters. A more modest 2-person precursor facility named Challenger Station is being built first. This organization is a do-it-yourself group of people from NASA (!), from various maritime backgrounds, and everyday sea and space enthusiasts, that has been managing to get its act together and finding some real corporate support. We introduced our readers to this outfit and their ambitious goals in MMM # 45 p. 11, May '91 [MMM Classics #5].

Meanwhile, the kind of facilities we've been talking about *can* be built and operated almost anywhere, even in your neck of the woods, by any dedicated group of individuals who really yearn to begin honest space pioneering, right down here, "on the homefront". EMMEL

More on "IXION"

ALPHA CENTAURI

In MMM # 43, March '91, as part of our Star*Bound Series, we featured an article about our neighbor star system, Alpha Centauri. A double star whose suns we dubbed **Ixion** (sunlike α Cent A) and **Nephthele** (cooler, oranger α Cent B) after the mythical king and queen of the Centaurs, this first logical destination beyond our Solar System has long been of interest. The MMM article delved in detail into the unique "white night" season system, with its repercussions both for native ecosystems and for prospective colonial society, that must follow from the pair's eccentric system-year long mutual orbital dance with its 80 year rhythm.

Two years ago, Ingemar Fureniid and Tom Meylan did in depth spectral studies (light wavelength pattern analysis) of the brighter of the pair at the European Southern Observatory in Chile. Their report was given in the September 1989 issue of the Electronic Journal of the Astronomical Society of the Atlantic, which was reprinted in full, with permission, in the January '92 [Space Views](#), the newsletter of NSS Boston.

Below the upshot synopsis of Fureniid & Meylan's findings.

By calibrating the Spectrum of Alpha Centauri A (Ixion) with that of the Sun, the investigators concluded that its surface is 90° Kelvin (or Celsius, i.e. 162° F) cooler than the Sun's at 5,700° K (9737° F). The indication is that the surface gravity is less than the Sun's and that it is further along in its evolution than our home star, aging faster as a star 10% more massive should. Elements Carbon through Zinc (numbers 6 - 30) are about 35% more abundant than in the Sun, only in part because the transmutations that are occurring through nuclear burning at the core have progressed further.

That zinc is the heaviest element enriched, with large enrichments of sodium, aluminum, manganese, and copper, and smaller enrichments of carbon, oxygen, and iron, imply to the investigators that the protostellar cloud out of which the Alpha Centauri system coalesced had been enriched by one more supernova than the material from which our own Solar System formed. Or in other words, the Sun and the Alpha Centauri pair *are not sibling* stars. **EJASA/SV/PK**

An Automated SHEET PILING Testbed for Lunar Construction

By Martin Dreves Jr. and Hugh Kelso

Seattle Lunar Group Studies (SLuGS) [Edited for length]

The fundamental problems facing the construction of a permanently manned lunar base are safety and economy. To minimize construction costs and EVA time while producing a safe structure, sheet pile construction concept was introduced. A teleoperated construction device could validate this concept.

The proposed testbed vehicle is a basic lunar lander with teleoperated equipment to erect an in-situ [on the spot] lunar habitat. The first goal is to create a non-pressurized 'storm cellar'; the second, a shirtsleeves environment habitat.

The lander uses a faring of several inter-locking sheet piles. The reusable testbed vehicle is to perform the maximum possible tasks to complete an in-situ habitat in one landing.

To complete its mission, the testbed vehicle must be able to perform the following: landing; sheet pile driving; excavation; placement of sealing end caps; placement of regolith shielding; and seal and pressurize the resulting structure.

Testbed vehicle with leveling legs deployed, lifting work package

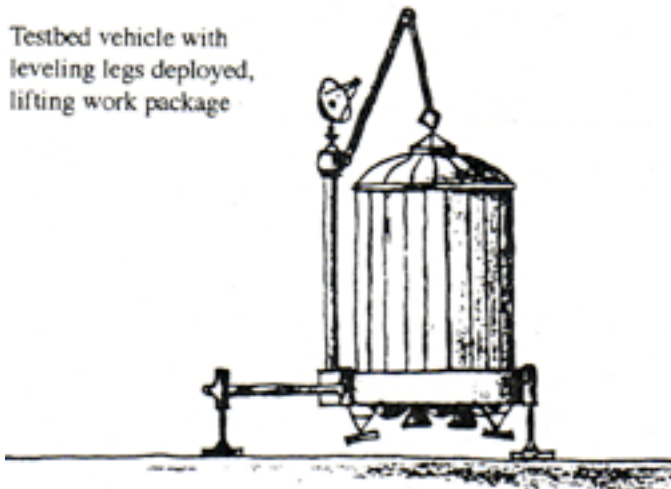

A 2-piece lander-crane/work package vehicle is simpler and more flexible than a combined lander/work package.

SEQUENCE OF EVENTS: 1) Landing. Surveyor and Apollo solved the problem of lunar landing and considerable data is available. Landing requires the testbed vehicle to include a throttleable descent rocket, fuel tanks, shock absorbent landing gear, navigation devices including a radar altimeter, and video cameras to pick a relatively obstruction free landing site.

2) Lifting the work package off the lander and placing it on the surface. An attached crane is used for this purpose. Its primary limitation is tipping moment. Extension feet of the

type used on earthbound cranes could be lowered to extend the base of the lander. This will minimize tipping moment.

3. Leveling. While leveling the vehicle was not necessary for Surveyor or Apollo spacecraft, it is important for the work package because sheet piling must be plumb to be driven effectively. Several different methods are available and off-the-shelf technology is available for performing this step.

4. Anchoring. After leveling, anchoring is necessary to prevent the action of pile driving from forcing the work out of plumb. Devices could include anchoring screws.

5. Lifting the end caps off the work package and setting them aside. The end caps used to seal the structure would be initially stored nested together on top of the work package. For the work package to perform its mission, these end caps would be removed and placed aside for convenient retrieval and later use. The lander crane does this using a hook.

A drawback of the separate lander crane/work package is the need to separate power supplies and duplicate tele-operations equipment. Cable connections made right after placing the package on the surface would eliminate this need.

6. Driving the sheet piles. This can be done by vibratory hammers contained within the work package and controlled by positioning arms with the ability to rotate about a central axis. The piles are driven sequentially in one foot increments to maintain inter-locking of the structure's sheets.

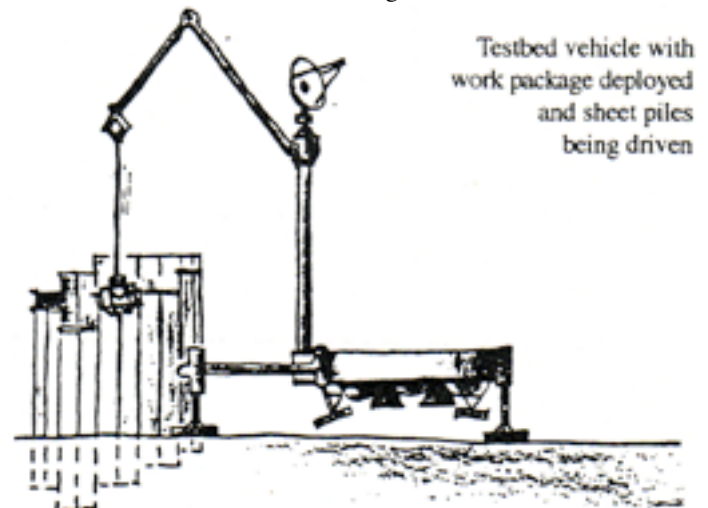

Testbed vehicle with work package deployed and sheet piles being driven

7. Unanchoring. This reverses the anchoring process, to move the work package out of the area to be excavated.

8. Lifting the work package off the surface and placing it back on the lander. This step is self-explanatory.

9. Excavating regolith. The lander crane does this with a clamshell scoop. More research is needed to investigate the feasibility of inter-changing the hook (used to lift components and release them when placed in the appropriate position) and the scoop. In excavating, the pit floor should be as level as possible for placement of the sealing ends.

10. The lander crane puts the bottom sealing fittings and end into the structure. Tops among several methods for this are the ledge and wedge techniques. In the former, the sealing end rests on a ledge formed by projections built into the sheet piling. In the latter it rests on wedges welded to the sheet piles. Both techniques have advantages and disadvantages.

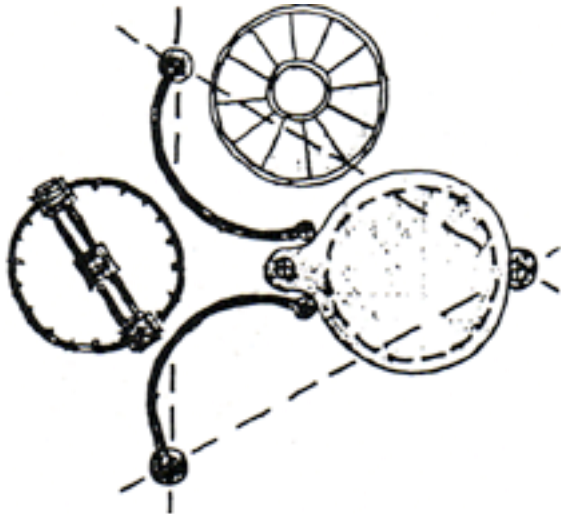

Top: leveling legs and work package deployed, end caps aside

11. The lander crane places the work package in the bottom of the structure. This allows the bottom to be sealed from the inside by welding or other mechanical means.

12. The crane removes the work package.

13. The lander crane places the top sealing end on top of the structure. Then the sealing end would be welded into place or sealed mechanically by 'dogs' like those used to seal a ship scuttle or hatch, a promising method. If the top ends of the sheet piles have a series of dogging holes, this method can be used even if all the piles were not driven to the same depth. Other methods: screw type lids, external dogging fittings, and interrupted bayonet screws used to seal artillery breach blocks.

14. The lander crane places regolith on top of the sealed structure. Using the clamshell scoop from step nine, radiation and thermal shielding regolith is placed on top of the structure, meeting the first goal of a 'storm shelter'. The amount of work required to meet the second goal of a [pressurized] shirtsleeves environment is minimal and the EVA time can be greatly extended because of the regolith shielding.

15. The lander lifts off for rendezvous with an orbital transfer vehicle. There it'd be resupplied, cleaned and checked for proper operation before being sent to build another habitat.

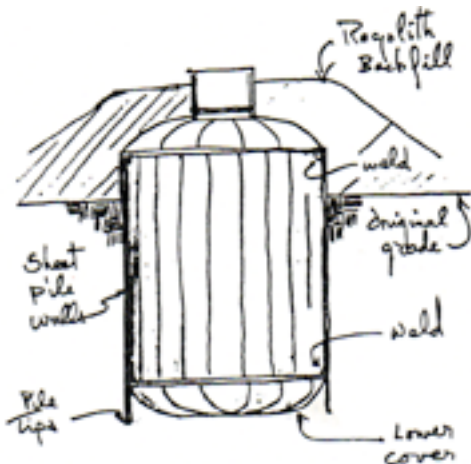

Completed sheet pile structure

SYSTEMS: Five basic systems are needed to perform the necessary operations are the landing system.

1. Landing system. This contains all items mentioned in the landing operation. A determination must be made if the landing is to be automatic or remotely operated. If automatic, a sophisticated high speed computer will be necessary to input the control parameters, velocity altitude etc., to compare inputs to normal parameters, and to apply correct controlling actions. If it is to be teleoperated, the remote operator must be trained to compensate for the 3 second round trip time delay. If this delay can be successfully overcome, the teleoperations system may be used in both landing and later operations.

2. Power supply. The operations discussed will take substantial amounts of power, (current planning indicates the sheet pile drivers alone would consume 223 KW/hr) perhaps in excess of currently available spacecraft power supply systems. Possible power supplies include solar regenerative hydrogen-oxygen fuel cells and radioisotopic thermoelectric generators.

3. Hydraulic operations system. Because of its ability to transmit power, multiply forces, and the considerable data on the subject, hydraulic operations appear to have an advantage over other methods of positioning materials and devices.

4. Electrical system. Basically the electrical interface between power supply, hydraulic, and teleoperations systems.

5. Teleoperations. This consists of a series of devices to perform the necessary operations in proper sequence. Fundamental components are a receiver to receive the signal from the control point, a signal processor (computer) to translate signals from radio pulses to a series of instructions for the remote operated devices, solenoid operated valves to control positions of hydraulic devices controlling positioning elements, position feedback transmitters to relay actual positions of various elements to the signal processor, video-cams to relay actual positions and progress, and a transmitter to relay information from cameras and position transmitters to the control point.

Several control point devices duplicate the function of counterparts at the testbed vehicle. Those that do not duplicate such functions are data and video display monitors to allow the operator to know what is happening at the vehicle, and control input devices to send controlling inputs to the remote vehicle.

ADVANCED APPLICATIONS: An advantage of this vehicle is that, if reusable, its only limitations are on the availability of power and of sheet pilings, both relatively simple and lending themselves to local production. If capable of recharging its power supply, the vehicle could be used for driving other sheet piles or performing other excavation tasks. Thus it could be used to expand an already built pile structure.

Sheet piling has advantages of stackability and high packing density. While our design concentrates on building a single structure of set size, it's possible to create a much larger structure than a fixed 'can' one-piece habitat with the same volume of material launched. This gives the same advantage as inflatables: large deployed volume with small packing volume, without dependence on pressurization for structural rigidity.

If validated by the testbed vehicle, usable lunar habitat volume can grow exponentially if initial lunar mining and manufacturing facilities can supply sheet piles and end fittings.

In addition, after manned presence begins, several components of this vehicle could be removed for use in other applications. Among these are the landing rocket motor and

associated fuel tankage and transfer systems. The teleoperations control point could be shifted to a nearby lunar location and the transmitter and receiver replaced by a cable. This will allow the operator to be in real time control of operations.

It is important to note that the sheet pile concept has been proven in earthbound applications. The testbed vehicle can be tested on Earth, before going to the expense of launching. The proposed methods for sealing the ends of the structure can be tested for effectiveness in a vacuum chamber.

Teleoperated construction offers economy and safety, minimizing exposure of construction workers to hostile lunar conditions and eliminating the expense of landing them and all their life support equipment until shelter is ready. **SLuGS**

MMM #57 - JUL 1992

Space Colonies: Redreaming and Redrafting the Vision

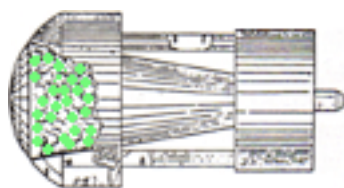

[Pioneering concepts: the forested space station of Tsiolkovsky on the left, the organically complete sphere of Dr. Bernal below right.]

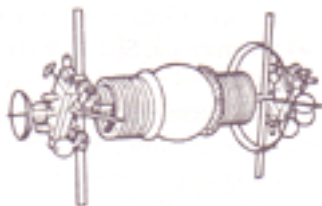

We best do homage to the legacy of Dr. Gerard O'Neill not by fundamentalist doctrinaire attachment to his *conceptions* of space settlements, but by adopting his *dedication* to the dream and *rethinking* the trial visualizations he gave us. "Xities" in Space! - See the four articles about "Xities" in space below.

[Series Continues]



Pronounced KSIH-tees, not EX-ih-tees

[Human communities beyond Earth's cradling biosphere]

By Peter Kokh

"XITIES" in SPACE (set of four articles below)

This month we take a look at mini-biosphere maintaining communities in free space, i.e. space settlements, or space colonies as they were first called. We took a unique fresh look at the architecture of these proposed oases in space in a set of 3 theme issues, MMM # 11, 12, & 13, DEC '87 to MAR '88. These articles, which approached the subject from a vantage point from which they had never been treated before (or since), are still timely [MMM Classics #2].

While we seem to be no closer today to realizing this grand vision of life unshackled to planetary surfaces than we were four years ago, the topic is long overdue for further review and constructive elaboration. Alas, there has developed

in some space enthusiast circles, a certain quasi-fundamentalist unquestioning dogmatic acceptance of the now classic expositions of the late 70s space settlement ideas. Given the high average intelligence of space enthusiasts, this is unsettling. We think that a better testimony to the inspiration of Dr. O'Neill is to be had in a no-holds barred critical review.

MMM # 11, 12, 13 "Space Oases" article series

#11 DEC '87

Editorial: "Space Oases and Lunar Culture"

Same raw materials early on, same results

1: Space Oases: "First Locations"

L5, L4, Resonant orbits, Low Lunar Orbits?

2: Space Oases: "Internal Bearings"

Scratch "spinward", "east" is the word

Directional cue colors for "english" in sports, dance

3: "Space Oases, the Moon, and Different Drums"

Vive La Difference between space settlers and planetary chauvinists! We need both.

12 FEB '88

4. Space Oases: "Static Design Traps"

Classic all at once designs have severe drawbacks

5. Space Oases: "A Biodynamic Masterplan"

13 MAR '88

6. Space Oases: "Baby Steps with Artificial Gravity: Back to Square One"

[These original articles are all available for download in pdf format as part of MMM Classics #2]

Space Xity Biomass Ratios

Xity > vs. < farms, gardens, parks, & wilds

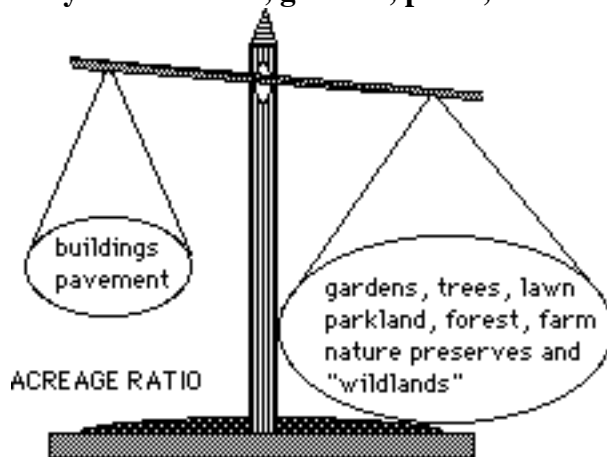

Making a successful space settlement, one in which air and water quality are maintained by a biological flywheel, is quite a bit more than a matter of simply reserving enough acreage for adequate food production. Yet that was the extent of the consideration given in the 1976 NASA Space Settlements Study. Our experience with Biosphere II, a complex life-cycle experiment now underway, should be sending everyone more than casually interested in human communities beyond Earth a jarring wake-up call. In this ambitious trial, several acres of luxuriant vegetation are

proving insufficient a match for the carbon dioxide exhalations of a tiny band of eight Biospherians and CO₂ scrubbers have had to be turned on.

We could simply adjust, rather radically, our expectations, providing plants for food and ambiance, but relying on chemical engineering methods for recycling air and water, with some bio-assist, of course. Yet the whole idea is to provide a secure environment. It is one thing to acquiesce in one's dependence on machinery to provide electricity. It is quite another to accept that the very freshness of the air we breath and the water we drink are hostage to machinery that could fail for want of a simple part stored in some warehouse a quarter million miles away.

If we do choose to forgo the security blanket of a relatively carefree biological flywheel, we'll need to provide redundancy in equipment, vigilant maintenance beyond all past precedent, and a religiously guarded surplus of spare parts. The probable philosophy of choice, will be to maximize the biological-assist component, relieving stress on the chemical backup systems, and providing more forgiving repair time in case of serious breakdown.

To this end, we need a change in philosophical outlook toward space xities, one that portrays the human as guest and plant life as host, rather than the other way around.

Farmland (and/or hydroponic gardens) must be provided in generous measure, ensuring food reserves for episodes of crop failure and disease. Residential areas must be more verdant than the most luxuriant of Earthside neo-suburban garden suburbs. Walkways and other pavings should be kept to a functional minimum. Rooftop space should be gardened. Interior spaces should use plants as the principal item of decor rather than as mere color accessory. Children should learn to care for plants. Green thumbs should be the rule.

To some extent this will all come natural as space settlers seek to wrap themselves in life against the searing stark sterile suction of the nothingness outside the xity's containment hull. Yet xity architects and planners must adopt codes and standards that will make such deliberately nurtured symbiosis with nature easy, not hard. There must be a pervasive tilt towards plant life.

When we look at the more commonly known and celebrated designs for space settlements, the early Bernal sphere, sometimes dubbed "Island I", stands out as an example. In it alone, a minimum agricultural vs. urban ratio is guaranteed by the very architecture - a garden-town gracing the "lower" terraces inside the sphere while generous farm space is provided in an adjacent *expandable* banded torus section.

Island II and Island III: Both designs, as they have now become classic-fixed in our minds, should be rejected out of hand as unviable.

In contrast the bigger Stanford Torus design of "Island II", and the bigger yet "Sunflower" design of the "Island III" O'Neill cylinder, each have no such architecturally guaranteed preserves but must rely on common sense to balance the

amount of limited acreage given to the actual settlement areas and that reserved for agriculture. This is an unstable tug-of-war arrangement which over the political long haul is likely to prove fatally fragile. I would submit that both designs, *as they have now become classic-fixed* in our minds, should be rejected out of hand as unviable.

Let's try some remedial surgery. The torus can be expanded to a banded version, several bands reserved to agriculture and nature preserves to each band "open" to settlement.

In the "sunflower", the acreage given to the threefold chevron-shielded window-rows are wasted, especially as more efficient ways of importing available sunshine are possible. For one, sunshine can be concentrated some three dozen times before being poured through proportionally smaller windows without over heating the glass, and subsequent diffusion.

Next, consider that more sunshine is collectible by outrigger mirrors than can be utilized within the single-tiered surface of the classical Island III design. The elegant solution is to have a number of concentric agricultural "basement" levels, each with adequate sunshine piped in through "suntubes", beneath the classic inner surface of the cylinder which can be reserved for settlement, gardens, and tame or wild parklands.

CLASSICAL SUNFLOWER DESIGN

Cross section

KEY:

- Chevron shield windows for Sunshine access
- ▨ Hull with shielding Farms, Parks, and Settlements on inner surface

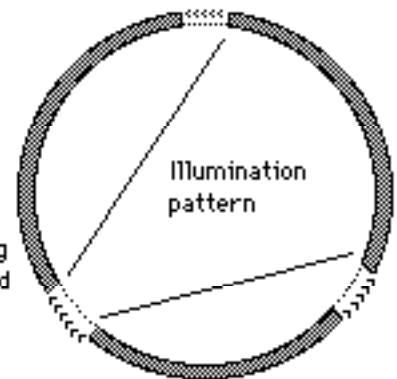

ENHANCED SUNFLOWER DESIGN

Cross section

KEY:

- ▨ Downsized Chevron shield windows for concentrated
- ▨ Sunshine access
- ▨ Hull with shielding Garden settlement on Innermost surface Farms on Basement Levels

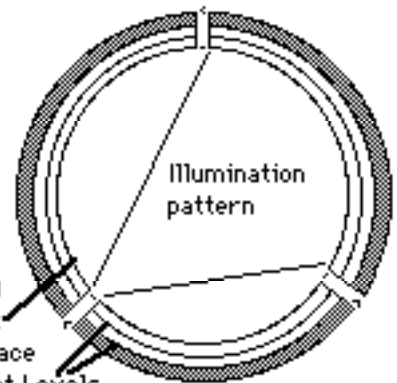

In both of the above revisions, architectural resistance to encroachment of settlement area upon agricultural and natural space is provided. I submit that it will be tantamount to mass suicide to build and settle such megastructures without such safeguards in place. Mere reliance on "common sense" and "good intentions" flies in the face of thousands of years of contrary human experience. FORMAL

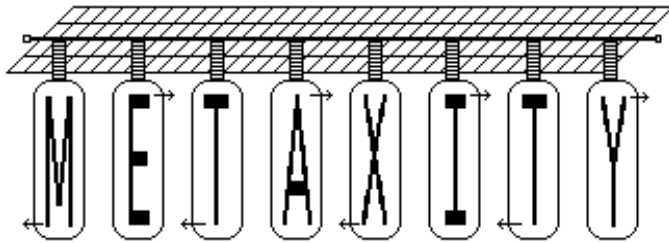

RESIDUAL PROBLEMS of Classical Space Settlement Designs and SYNTHESIS via Polymerization on the "METAZOAN" Plan

Escape from Premature Completion

If it is a critical challenge to maintain a sustainable symbiotic balance between acreage surrendered to settlement and that dedicated to agriculture and the air and water bioregenerative flywheel, then the ultimate devil in the works is population growth and pressure. The fixed size, expansion-unfriendly character of individual Bernal sphere, torus, and cylinder space settlement megastructures, each as classically conceived, is reason enough to look for altogether different architectures. Is it possible to postpone, if not ultimately avoid, the soul-decaying stagnation of limits to growth in individual settlement megastructures?

As we pointed out four years ago in our previous double article "Space Oases: Static Design Traps" and "A Biodynamic Masterplan", the ivory tower assertion that the only possible architectures are sphere, barbell, torus, and cylinder is so much arrogant pedantic static-thinking hogwash. None of us would be here if nature hadn't found an escape from such limits in the "double helix" of DNA. To put it conceptually, a barbell is moved sideways along its axis as it rotates, to generate a doubly open double helix *rather than* a closed self-suffocating tail-in-maw torus.

In the classic designs, completed structures must be built before occupancy can begin. In the biodynamic double or triple helix twist on the torus, occupancy can begin as soon as an initial "dumbbell" section is completed, and the xity can grow and grow and grow as needed towards some eventual desired maximum population capacity, ever adjusting its biomass ratio as it grows. Here we have an architecture which is both biologically and psychologically and socially healthy.

The classical solution to population growth in space settlements is, of course, to simply build more of them, letting individual settlements suffocate in their own limits while all or almost all the young must move out in some weird lemming-like parody of "coming of age." We think there is another alternative, an option other than wholesale generational abandonment of one's atrophying fixed-size home-xity; other too, than that of the more imaginative growth-friendly Double and Triple Helix Settlement architecture. First let us look at some other unanswered residual problems of the classical designs.

Xity Economies and the Three Shift Problem

Protests of trendy brain-fried economists to the contrary, there can be no such thing as a post-industrial "service" economy - *except locally*. Somewhere, "out of sight out of mind", *every* economy must start on the farm and continue to pyramid through the factory. Ah yes, manufacturing, where the expense of plant and machinery demands around the clock use.

Three shifts!

The majority of space advocates seem to be employed in managerial, office, engineering, and service occupations plied during daytime hours. We might expect them then to be chauvinistically content to continue the Earth-rotation imposed tyranny that condemns many to work at night and sleep by day. Yet isn't the very glory of the space settlement that it provides an opportunity to pick and choose the Earthlike conditions we want to keep and those we want to discard? In the LRS Prinztown rille-bottom settlement design study, the town was segmented into three interconnecting villages with day-night cycles staggered 8 hours apart so that everyone could sleep "at night" and work "by day" while the machinery continued to be operated around the clock. Night shift in one village would be crewed by 1st shift workers from another.

While the same elegant solution can be provided by the architecture of a Triple Helix Oasis, with its three strands observing staggered time zones, it would seem that blue collar workers in one of the more classically designed Space Settlements would be condemned to the same life-shortening fate that is their common lot on Earth.

Almost, but not quite. In external work, at least, i.e. the construction of new space settlements or of solar power satellites, two or more space xities could team up to do the job, each with shift-staggered sunrises and sunsets.

Indeed, a sort of Siamese pairing has been suggested, in which two oppositely rotating cylinder type settlements are connected to one another at both ends by torque sharing cables. In such a setup, travel between the pair could be quite routine. But this still does not provide three shifts, the conventional ideal. Perhaps one doubly massive prograde cylinder could team up with two retrograde rotating cylinders each half the size in a torque-free system? The larger one would house the managerial, office, and commercial class as well as its share of shift workers. Another surmountable engineering problem?

Other Rationales for Settlement Match-Making

Apart from task sharing by shift management, could settlements be paired to correct biosphere flywheel imbalance? i.e. could the connecting torque-sharing cables also pipe fresh and stale atmosphere back and forth? An over-settled over populated settlement could be paired with a heavily rural one. The engineering problems to be overcome are just that.

These are not new problems. Nature faced a similar situation several hundred million years ago when the design limits of one-celled creatures threatened to bring further evolution to an incrementally moot halt. Colonial organization like that in the order of sponges allowed some of these design limitations to be transcended.

Why not take this discussion of limited pairing to its logical conclusion and design workable aggregations of space settlements to enable them to do *physically together* what they could not hope to do physically apart, even with cooperation?

Eventually, nature came up against severe limitations in the colonial organization also. The shackles came off when some colonial cells started to specialize, allowing organs and organization to appear: metazoan life, of which we are the present climax on this planet. Can physically colonial associations of space settlements go beyond sharing to group special-

ization? *Can meta-xities be possible?*

If so, the standard expectation (to the great glee of the anarchists among us) that each space settlement is likely to be a politically sovereign entity, encouraging a bloom of social and political experimentation, may be realized only in boondocks areas of space such as Earth-Moon resonant orbits where any meta-structure would tend to break apart from tidal forces. Both in Earth-Moon and Sun-Earth L5 and L4 areas at least, physically stable colonial and meta-organization, if possible, are likely to prevail, each settlement being but a county, state, province or whatever of some greater much more capable and richly endowed space nation. But we get ahead of ourselves.

Let's throw out some architectural ideas - meant as trial balloons. If you find a flaw, and please do play the devil's advocate, go on to find a solution and further improve the suggestion or supplant it with something better. Here we are not trying to pose ultimate solutions. Rather our intention is to break the mold of stagnant thinking on space settlements, leading to an outburst of fresh designs, some of them perhaps able to reignite public enthusiasm as the now classic designs did fifteen years ago in the late seventies.

THESIS: if an Island hub is non-rotating, it can be docked thereby to a common utility and service platform along with other islands with non-rotating hubs. Take another look at our title graphic METAXITY at the start of this piece. It is meant to be deliberately suggestive.

SHOWN: a giant solar collector power grid system for power sharing among a number of cylindrical settlements, each attached to the grid at a swiveling pole, half of them rotating prograde, half retrograde for overall torque neutrality. There is also a transitway linking the "docked" hubs of the several settlements to allow easy travel between them.

NOT SHOWN: A shared radiator system, a common space port, shared zero-g and fractional-g ware-housing, agricultural, manufacturing, and laboratory areas.

And use your imagination to suggest what other things permanently docked Islands might now economically do together as an archipelago that any one Island might be too small to do alone. Nor rest content with embellishing this basic architecture. Try to come up with other architectures for physical association and task sharing.

The classic Island designs are great for daydreaming. Now is the time to start sketching the outlines of a more realistic future world in free space.

The promise of the Meta-Xity

- correct biosphere flywheel imbalance for Islands whose architectures do not make them individually expansion-friendly.
- shared zero-g food-production agricultural acreage
- shared recycling air and water grids
- energy and heat-radiation grids
- facilitate inter island travel in people and goods and supplies and energy
- provide three staggered daytime shifts without pain
- more easily shared construction projects
- shared warehousing of incoming raw materials, solid, liquid, and gaseous, and outgoing manufacturing products.

- spaceport sharing and space traffic control
- shared metropolitan center for culture, entertainment, educational and governmental institutions
- a sound basis for a common market and political federalism
- manage L4,L5 crowding without catastrophic collisions and expensive station- and formation-keeping fuel expenditures

No Settlement is an Island unto Itself

Thus the island concept familiar to most of us is like a conceptual "monomer". The unsuspected promise is in the unlimited versatility and innovative chemical freedom afforded by polymerization. Space Meta-Xities (Metas?) or Shelf-Sharing Archipelagoes (SSAs?) of space oasis island settlements will make O'Neill's dream come true. **[METAXITY]**

[Space Xity Architecture Issues Cont.:]

"Artificial" (Centrifugal, not Centripetal)



What level should be "the Standard"?

In the world of Space Settlement enthusiasm, there is no cow more sacred than Earth-normal gravity. The ability of rotating megastructures in space to provide customary weight levels for masses of people is taken without question as one of the keystone assets of the whole space settlement concept.

Indeed to question "the standard" is tantamount to heresy. Maybe. But even more certain is our conviction that anyone afraid to question the truth does not deserve to possess it. Let us then risk heresy and dare to ask questions.

The ISSUES: A) Settler and Visitor Health; Readaptability to Earth-Normal Conditions; Health Insurance Dictates

The classical arguments for Space Settlements as opposed to those on planetary surfaces would seem to be twofold: 1) far more total livable surface can be created with a multiplicity of rotating shallow hulls on the inner surfaces of which artificial gravity is provided by centrifugal force than on the surfaces of deep-cored planetary surfaces through the centripetal force of natural mass/inertia provided gravity. This argument becomes important only as the economic justifications for very large off planet populations are actually realized. This scenario is more likely to follow heavy reliance on Solar Power Satellites than a decision to go with Lunar Based Solar Arrays or a Helium-3 power generation economy. The jury is out and it will be some time before the choice or exact mix of choices is settled on either economic or political grounds.

2) In rotating space megastructures, it is possible to set any gravity level desired, and not be restricted to the fractional gravities provided by natural bodies on which settlement has been proposed. [16% on the Moon, 38% on Mars; *physiologically* negligible on even the largest asteroids]. In absence of evidence to the contrary the conservative assumption is that the human physiology which has evolved in Earth's

gravity, will continue to do best in a similar environment. Hence Earth-normal 1G should be provided.

This argument would seem to be strong. Certainly, settlers and visitors to an off planet 1G environment would undergo no physiological deterioration and could readily return to Earth if they so desired. This point is especially important to space enthusiasts who down deep aren't quite sure they are ready to burn their bridges behind them. Certainly, it is inarguable that freshman settlers should opt for a 1 G space settlement, at least as a temporary home (much like New York City has been for wave after wave of immigrants) until they are sure they like living in space enough to care not whether they ever returned home. This is a sad commentary really. Most of the immigrants to this country from Europe came without any such uncertainties or reservations. In plain fact, the "right stuff" is nowadays a very uncommon virtue, even amongst our own ranks.

We won't dispute that if we are talking not about permanent space settlements but temporary "construction shack towns" in which rotating crews come up from Earth on limited tours of high pay duty to build Solar Power Sats, 1 G ought to be the standard. Employer-paid insurance will no doubt demand it as a condition of coverage.

But what about settlements for those who are sure at the outset, or become convinced after a trial, that life in free space suits them fine, that they do not miss the attractions of old Earth (tourism; many sports and outdoor activities which will not translate well to Space Settlement environments; their relatives and friends left behind)? What in fact would be the health implications of another choice?

It would not seem likely that anyone would want to pick a gravity environment in which they would weigh more and have to work harder. Those who hope to someday settle Mars may wish to live in the meantime in a Space Xity that offered Mars-level gravity 3/8ths that of Earth-normal. Other than that, those making repeated long trips (deep space exploration, asteroid prospecting and mining, etc.) in a zero or near-zero gravity environment would probably much prefer a home base that offered a gravity level much lower than Earth's but just high enough to sustain a lowered plateau of physiological normalcy. It would be far easier for inveterate spacers to call the Moon or some Moon-like space xity "home" than Earth. In plain fact, those who need to readapt periodically to Earth will simply not choose such occupations.

One of the weirdest examples of twisted logic now prevalent is that if human physiologies deteriorate unacceptably in zero-gravity, then by Sagittarius (and by Pisces and by Libra etc., if you catch the aspersion), the 1/6th level offered on the Moon's surface is something to be avoided at all costs. In point of fact we have no sufficiently prolonged experience with *any* level of fractional gravity to offer in evidence one way or the other. Apollo stays were much too short.

Logic says that *very* low gravities are functionally the same as no gravity at all, at least if we are talking about gravity-assisted blood circulation patterns. There must be some point at which the lowered gravity is canceled out by the coefficient of friction in veins and arteries. My guess is that such a situation will be the case on the asteroids. Even Ceres,

the largest and most massive, offers no more than 3% of Earth-normal and that might as well be zero as far as physiology goes, however much it might be helpful mechanically in construction, and domestically in keeping things put.

At the same time, there is absolutely no grounds to believe, timid nellies notwithstanding, that long-duration stays on the Moon or in a 1/6th G simulation facility in LEO will show anything other than that decline in physiological health and muscle tone *levels off at an acceptable plateau*, one that can be maintained on a life-long basis, from which rehabilitation to Earth-normal life may be difficult, but not impossible.

Oh yes, insurance! Insurers may be conservative, but they are not stupid. In point of actual fact, in the real world most of us like to ignore there are some number of physical conditions which are much aggravated, necessarily *now*, by the naturally high level of gravity on this planet. Rheumatism and arthritis, cerebral palsy and other motor impairments, to name a few. Might not insurers, if forced to continue coverage for the sufferers of such ailments (against their obvious desire to cover only the healthy who won't be making claims), have an obvious interest in "encouraging" clients suffering from such conditions to "move" to lower-G environments when they become available? In time, conservatism or not, the G-level should become an insurance-neutral question.

The ISSUES: B) Structural Integrity and Safety; The Size and Mass Threshold for Occupancy

If the health question eventually does prove to be moot, as we predict, are there any architectural motives to pick a different standard than that of Earth-normal 1G? At the time the classical space settlement designs were being put forth, the conventional wisdom was that humans could adapt to a rotation rate of 3 revolutions per minute. Since then the indications are that while this may be so for a small select minority, if we want to make life acceptable for others qualified and willing to out-settle on all other accounts, we may have to observe a 1 rpm constraint. For very large islands like the Sunflower cylinder (Island III) this is no problem. Its radius is in excess of the 1km (1,000m or 3,000 plus ft) necessary to provide 1G at 1rpm.

But for many of the torus designs proposed, certainly the Von Braun wheel from the film 2001(!), only much lower fractional gravities could be produced at 1rpm at their proposed much smaller radii. This goes for the Bernal sphere as well. In fact cutting design rpm from 3 to 1 while maintaining design gravity levels automatically demands an increase in radius by a factor of 3, **an increase in shielding mass by a factor of 9, and of structural mass by a factor of 27**. Suddenly the economic threshold for their construction becomes dauntingly high. Indeed the first such space colony might never be built. End of dream.

In contrast, if while the rpm is cut from 3 to 1, the design gravity level is also cut from 1 to 1/6th, then the original radius proposed can be cut by 2, **shielding mass and the cost of outfitting cut by a factor of 4, and structural mass by 8**. The population capacity is also quartered. Suddenly the threshold for the construction of such space habitats is lowered and is more economically attainable. The first such habitat will be markedly easier to sell to its investors and take much less time and money to build and be the more certain to prove a

profitable venture. Lunar standard space settlements will multiply and thrive, the per immigrant cost *markedly* lower.

In this light, it begins to seem odd that some of the same folk paralyzed by the need to lower the cost per payload weight to orbit, would want to insist on unnecessary Building Codes certain to escalate greatly the cost of space construction. Timeout, fellas! Time for a review of hidden assumptions.

Along with ease and lowered costs of construction, a lowered G standard per se lowers the level of centrifugal structural stress and with it the probabilities of structural failure (especially for essential exterior paraphernalia like cable-bound outrigger mirrors). A lunar standard space oasis will be a measurably safer place in which to live and work, one whose integrity is maintained much more easily, one whose life expectancy is measurably longer.

For all these reasons, the 1/6th G lunar standard is likely to be adopted by all long-trip spacecraft providing artificial gravity: cycling hotel ships on the Earth-Moon and Earth-Mars runs; the habitat ships of asteroid miners, etc. In contrast 1 G standard space habitats and ships, if ever built, are likely to be pink elephants from the drawing board to their premature decommissioning.

It's time to desanctify the cow of the Earth-normal gravity "standard" once and for all.

Our conclusion is simply this. The impassioned proponents of a 1 G Earth-normal standard should be honest enough to realize that theirs is a chauvinism every bit as quaint and curious as that of those who want to live on the sky-facing outside of some planetary surface. It is time to desanctify this cow once and for all.



**What orbits will Space Xities ply?
Who will allocate them?
Will there be annual "parking" taxes?
Will this extend the authority of Earth to
the "Unreal Estate" of special orbits
in Cis-Lunar Space? in Earth's Solar Orbit?
The battle over the Moon Treaty may be
just the beginning!**

1. L5 or Resonant Orbit?

Back in the mid-70s, it was proposed that Space Colonies be established at one or both of the two stable Earth-Moon Lagrangian points, L4 and L5, centering 60° ahead and behind the Moon respectively in its orbit about the Earth where they would fly forever in equilateral formation with Earth and Moon. These co-orbital fields required little energy to reach from the vicinity of the Moon, whence the raw materials necessary to build them would come. This insider wisdom gave the L5 Society its strategically esoteric name.

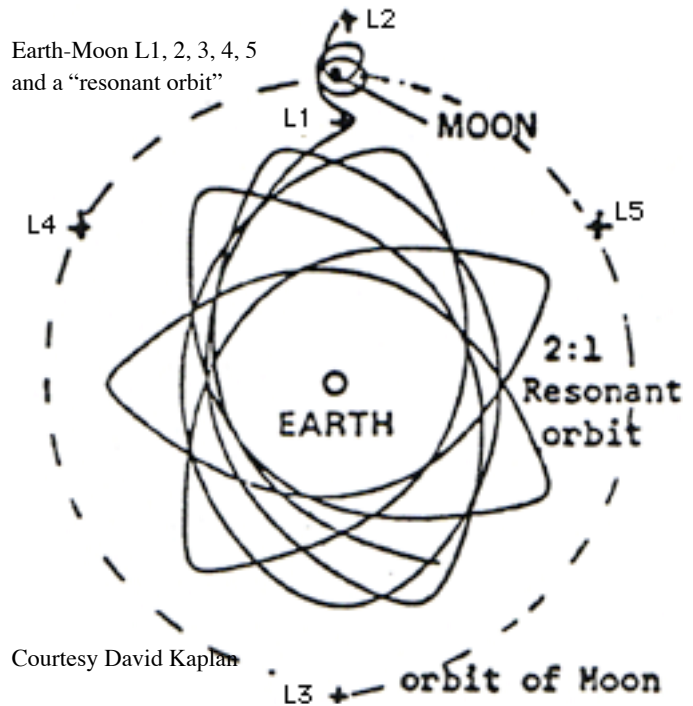

Courtesy David Kaplan

Subsequently, this conventional wisdom was replaced by one allegedly more savvy which proposed that such habitats be built in Earth-Moon resonant orbits, eccentric ellipses that would bring the community close to Earth and then close to lunar orbit twice a month in an orbit whose apogee precessed around the clock once a year. Many jumped on the bandwagon of the resonant orbit idea, convinced by the numbers of orbital mechanics. The trouble is this suggestion does not stand up under scrutiny. Yes, it is the sort of orbit easiest to reach from the Moon. But, if we are going to see a great many space settlements, they will have to be placed in a succession of such orbits such that one succeeds the other in reaching apogee as the Moon orbits by, in a what would appear to be a stationary wave. If one was allowed near the Moon per day, that would leave room for only 28, every twelve hours 56, every hour 684. Because of tidal forces, "metacity" physical agglutination of such island communities sharing facilities and assets in common, would be quite impossible. Thus the room for space xities in resonant orbits, and the limits placed on their evolution there, are quite severe. A nice ivory tower idea, but that's all it is.

Resonant orbits will be used, of course, but not for permanent space settlements. Rather such orbits should and must be reserved for something entirely more appropriate, cycling Earth-Moon transit hotel ships, in which settlers and tourists can make the several days long journey in luxurious comfort. These orbits will be allocated, and the companies using them may pay an annual fee to do so.

2. L5 and L4?

So the original L5 concept was right on target after all! Here not only can great numbers of individual (rural) space settlements be built, but also they can come together to form metropolitan meta-xity complexes, physically contiguous space nations. Without this development, space settlements cannot reach their full potential, and the total number safely allowed in the Lagrangian field will have to be more limited.

L5 will need some governance. Orbits of discrete individual settlements and larger meta-xities will need to be allocated with complexly choreographic care to minimize the risk of near collisions with the minimum of reserve station-keeping and emergency maneuvering fuel. While the authority allocating resonant orbits for the transitel trade will probably be Earth-based, L5 could be regulated by a cooperative association of the settlements already there. They would collectively have the autonomy to decide if, when, and where more settlements are to be allowed. While such Lagrangian home rule is proper, it may have to be fought for in a political struggle, especially if proposed newcomers would be owned and puppeteered by Earthside nations.

And L4? Why not? It has the same physical characteristics and orbital mechanics, the same carrying capacity.

Lesser “unreal estate” for “parking” space xities GEO, LEO, LLO, L1, L2, L3

The economic rationale behind the majority of space xities in Cis-Lunar space will be the manufacturing of Solar Power Satellites along with more of their own number in anticipation of a *steadily* accelerated need. However there will be lesser niches. There may be room for one, two, at most three in GEO[synchronous Earth Orbit] where their livelihood would be twofold. First they would maintain communications and weather satellites whose total numbers will have increased dramatically once they are “packed” together aboard fewer crystal-tight power sharing platforms. Second, they would maintain and repair Solar Power Satellites in GEO.

There will be room for one or more “resort” xities in LEO, low Earth orbit, catering to the bulk of Earth tourists venturing into space. They will offer angelic views, zero and simulated other planetary gravities, unique recreational and athletic opportunities, and perhaps pursuits outlawed on Earth. There may be one which serves as a hospital complex specializing in zero-G and fractional-G treatments.

A xity in LLO, low lunar orbit, may be the principal gateway to the Moon, the transfer point for space-captive luxury craft and orbit-to-surface taxis, shuttles, and lighters.

Some sort of facility at L2, 40,000 miles above the lunar center farside, is a possibility if it proves necessary to “herd” the volley traffic from below. Lunar mass drivers will boost payloads of raw materials and smaller containerized value-added products through this point. A xity at L2, and any at L1 above nearside, would need station-keeping fuel as these Lagrangian points are unstable.

In any political geography, there is always the spot for which there is no economic justification, off the beaten track, *therefore* of value to the idle rich wishing not to have to brush shoulders with those who have to toil to earn there keep. In space, L3, the Lagrangian point at lunar distance on the opposite side of Earth from the Moon is just such a place. An orbital Scottsdale or Palm Springs at this location would not mind the necessary expense of station-keeping required.

Location, Location, Location

The assets of SUN-Earth L4 and L5

Yet it could be a mistake to assume from the above that the vast bulk of space xities will be in the Earth-Moon advance and trailing co-orbital Lagrange fields, L4 and L5.

These may simply be the most crowded places in Cis-Lunar space, the space around the Earth within the Moon’s orbit.

For once asteroidal resources begin to be tapped, and this should occur simultaneously or quite shortly after raw materials begin to flow from the Moon, then two other much vaster more capacious locations suggest themselves centering 93 million miles away, 60° ahead of and behind the Earth in its orbit around the Sun, SUN-Earth L4 and L5.

SUN-Earth L4/L5

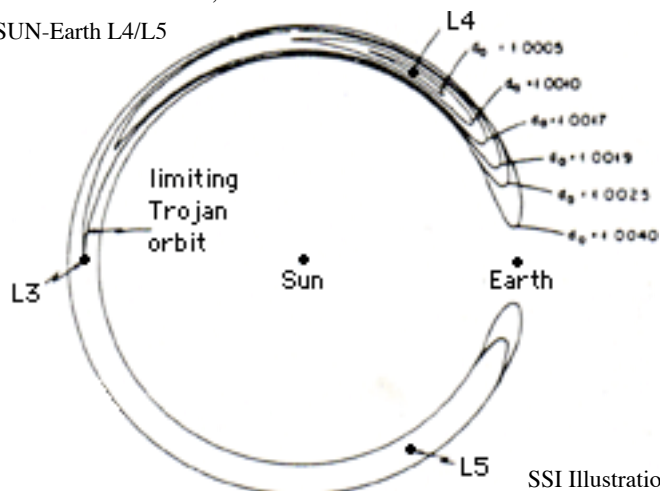

SUN-Earth L4 and L5 emerge as the premier sites for space xities involved principally in the processing of asteroidal resources for two reasons. First there is likely already a certain amount of asteroidal material in these twin co-orbital fields. That no chunks have yet been identified or located there puts an upper limit on the size of what we can expect to find of perhaps 3 km (2 mi) in diameter. But the astro-chunks or planetesimals easiest to mine and process will be these smaller ones anyway. This lode may include self-snuffed comet hulks.

Second, if it is necessary to range into independent solar orbits in search of exploitable flying mountains of ore, our first hunting grounds will be the near-Earth orbits of the Apollo, Amor, and Adonis asteroids wholly without, intersecting, and wholly within the Earth’s solar orbit respectively. We will look principally for those small enough to be corralled and with trajectory energies relative to Earth (i.e. ΔV) low enough to be brought into more convenient parking orbits for further* processing. (*The mass driver which will accomplish this trick, will in the process have begun separating prized ore from “tailings” to be ejected as reaction mass.)

And where will we reserve such parking space? Contrary to common expectation, *not* anywhere in Earth-Moon space. First, Earth-Moon parking slots will be reserved for inhabited megastructures. Second, it is unlikely that the public on Earth would welcome the minute but finitely positive chance that a herded asteroid could by human error or simple lack of a mid-course correction be sent plummeting directly Earthward in a dinocide re-run. Politics and public fear are likely to demand a safer herding ground: SUN-Earth L4,L5.

So even if these vast circum-solar Lagrange areas are currently a resource desert, they are likely to become resource dense by human intervention. Hence here will be the bulk of asteroidal resource processing. Some manufacturing will be done here. The balance of these processed materials will be container-shipped back to the Earth-Moon vicinity.

If Space Settlement is ever to develop a mutually interdependent economy in which exports to Earth-Moon become a lesser factor, it will be here, in SUN-Earth L4 and L5. Here the “circumsolar” economy will come of age, succeeding the Earth-Moon economy. Here will be built the most extensive, most populous, most ambitious and most organically differentiated meta-xities. Here may be built great powerful solar lasers to power near-interstellar robotic probes and the even more ravenous C.E.T.I. beacons, in century-long dedication to the task of sending messages to unknown listeners around other unknown suns. Here, some distant day, may be born the economic launchpad to the stars!

Other Space Xity sites out of Earth Orbit

There will be many other specialized limited niches for human communities in free circum-solar space. Cycling hotel ships serving settlers and tourists bound from Earth-Moon to Mars. Miner settlements in elevator-anchored surface-synchronous spots above the larger Main Belt asteroids. Grand Tour retirement communities doing the sights of the outer System including an unforgettable close ring-pass of Saturn. Helium-3 mining communities in orbit above Uranus. These are some of the more likely possibilities.

Site Rationing

Suitable parking spots in space are more abundant in some areas than others. Where the “carrying capacity” of the niche is either economically or traffic-wise limited, there may well arise the need to allocate, lease, or sell and tax such spots. However unreal and limitless empty vacuum may seem, orbits and trajectories are very real and finite indeed. It will be these, not sheer vacuum, that have economic value. Alas, there may be no escaping the assessor!

[Series Continues]



Pronounced KSIH-tees, not EX-ih-tees

[Human communities beyond Earth’s cradling biosphere]

By Peter Kokh

Xities Serving Asteroid Miners

It has been customary in Science Fiction to portray asteroid mining and prospecting as essentially a matter of small scale group, Mom & Pop, or even individual operations. This romantic notion appeals especially to those of us who fancy ourselves more ruggedly individualistic and self-reliant than we really are, and serves as a let’s pretend outlet for the frustrations we all feel in dealing with a large pluralistic society. There’s lot’s of elbow room out there, and operations WILL be scattered, millions of miles and months of travel time between the early pioneers. Apparent *real* freedom!

Yet, whatever the scale of operation, there will still need to be a handy few centers where a prospecting or mining effort can purchase new or reconditioned equipment and fresh supplies: vehicles, tools, food rations, etc. There will still need to be places where these hardy folk can come for postponed treatment of neglected health conditions. There will need to be assay offices and markets for their production, courts to settle their disputes, shops to repair their space vehicles and mining equipment, labor markets to find replacement and additional help as well as simple relief from loneliness. Opening up the asteroids will require strategically placed frontier towns just as did the opening of the American West.

Where?: Most Science Fiction yarns dealing with the subject, take place in the Main Belt - that’s all that was known to the writers. Until recently, we’d only discovered a very few Earth approaching asteroids, straying, or residing, well inwards of the main population between the orbits of Mars and Jupiter. Eros, Hermes, and Apollo and a few others were found years ago. Today we suspect that there are probably a few thousand lesser astrobits that range much closer to Earth. They are for the most part small objects a couple of miles across at best, and most of them no more than flying mountains, an attractive plus. A small astrochunk can be herded, substantially intact, to near Earth processing sites by means of a mass driver. We could thus presume that the Xities serving asteroid mining operations would *initially* be those in Earth orbit and on or near the Moon.

We’ve suggested previously that political considerations like the perception of safety, may lead to the shifting of primary corralling and subsequent processing of herded asteroid lodes out further, perhaps to the Earth-Sun L4 /L 5 “Trojan yards” centering some 93,000,000 miles from the Earth-Moon system at points preceding and trailing our twin home worlds in their orbit around the Sun. Travel between these points and Earth/Moon would be via low-energy trajectories as well as “window-free” i.e. able to be undertaken at will, *at any time*. So we may see some xities serving asteroid mining operations at these formation-flying “Earth Equilateral” locations.

MMM #58 – SEP 1992

Moon Pie Recipe calls for Asteroidal Seasonings.

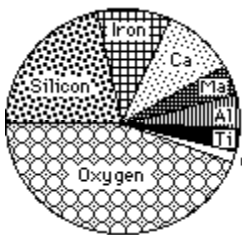

The pie chart at left shows that the Moon has some great ingredient ‘cupfuls’ for a space-based civilization recipe. But if building materials were enough to support an advanced technological civilization, Tibet would be as ‘today’ as Texas.

We’ll have to turn to the asteroids for some of the ‘teaspoon, teaspoon, and pinch ingredients’ wanting. And “xities”, right, will be needed to serve asteroid miners. ⇒ *Read below.*

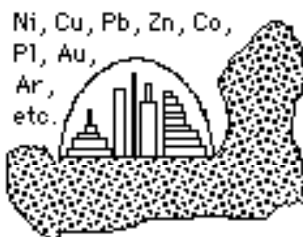

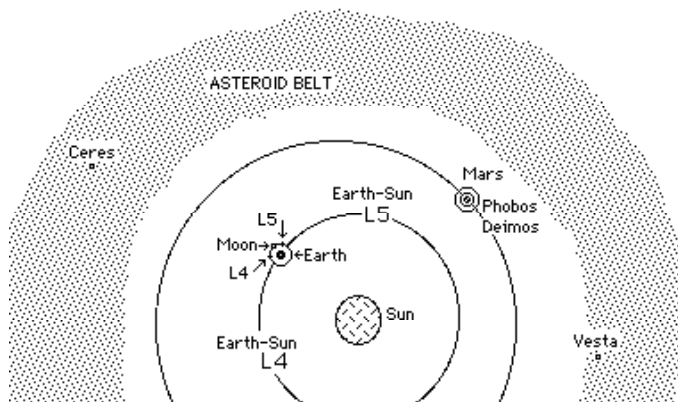

Locations for Xities Serving Asteroid Miners

The Moon, Low Lunar Orbit, Earth-Moon L4 & 5

Earth-Sun L4 & 5, Deimos, Ceres, Vesta, other Main Belt Asteroids

However, it would be surprising if our growing space-foraging economy did not soon need to range further afield. For one thing, it is not at all clear that the “asteroids” to be found in Earth approaching orbits are typical of the Main Belt population. A number of investigators are becoming more and more expectant of finding that perhaps more than half of such objects are really “retired” comet hulks, their vent pores plugged with dust and slag, choking off their former cometary head and tail making activities even this close to the Sun.

Actually this is very good news for those searching for handy cheap volatiles necessary for life, agriculture, and industry with which the Moon is poorly endowed, e.g. carbon, nitrogen, and hydrogen especially. (Such sourcing, if it can be done on a dependable basis, *might* slow the growth and evolution of a human presence in the Mars System, whose two moonlets Phobos and Deimos are likely alternate sources of such volatiles. Turned-off comet hulks would present a much richer, though trickier to develop supply.) [See MMM # 35 May ‘90, p.4. “Wildcatting Comet Crude” - MMM Classics #4]

By the same token, those seeking lucrative metallic ores could find slimmer pickings than they had previously expected. The most rewarding enriched ore deposits may just happen to lurk out in the Main Belt, beyond the orbit of Mars. For most first-thought-is-last-thought “visionaries” this means that Deimos, Mars outer moonlet is likely to be the “Asteroid Central”: launch point and *the* place for provisioning and outfitting Belt expeditions, and for repairs and marketing.

Mars orbital proximity to the belt, could be, counter-intuitively, a drawback. It is a corollary of orbital mechanics that the closer the orbits of two objects, the *less frequent are the windows* of opportunity for launching from one to the other by minimum energy Hohmann transfer trajectories, the only economic choice for chemical rockets. For personnel and goods originating in the Earth-Moon system, it makes more sense to go direct. Once similar goods and services are available at Mars, it may still make sense to use Earth/Moon as a supply source when urgency of delivery, rather than fuel cost, is the essential consideration. Yet Deimos (Mars) is a logical sources of planned regular “pipeline” shipments. So Deimos should play a support role, but maybe not much more.

Hohmann Transfer Window Frequency:
(more often from the vicinity of the Moon) months

Moon/L4&5	to	Ceres, vice versa	15.3
(Mars)Deimos	to	Ceres, vice versa	20,3
Moon/L4&5	to	Vesta, vice versa	17.1
(Mars)Deimos	to	Vesta, vice versa	27.1
Ceres	to	Vesta, vice versa	17.08 yrs

Hohmann Transfer Travel Times:
(quicker from the vicinity of the Moon) months

Moon/L4&5	to	Ceres, vice versa:	15.5
(Mars)Deimos	to	Ceres, vice versa	18.9
Moon/L4&5	to	Vesta, vice versa	13.1
(Mars)Deimos	to	Vesta, vice versa	16.3
Ceres	to	Vesta, vice versa	24.7

LESSON: When fuel expenses are secondary to timeliness, resupply from the Moon or from space xities near Earth, will often be preferable to using Deimos, depending upon where each are in their orbits about the Sun.

If/when nuclear propulsion becomes the norm, there will be more freedom to travel at less than ideal “window” times by less fuel-efficient, quicker trajectories. Then the ideal service center will be the one that happens to be the nearest at the time. How close Mars’ orbit is won’t matter if it happens to be in the wrong part of it at the moment. Asteroid pioneers will need to be covered by a number of resupply options.

Ultimately, xities in the Belt itself will be economic imperatives for logistic reasons. Ceres and Vesta are two likely hosts. [see MMM # 24 APR ‘89 pp 4-6. CERES, PALLAS, VESTA. MMM Classics #3.]

“If the statistics for the first 100 asteroids to be discovered are typical, 44% have orbital periods within 10% of Ceres so that one third of these or almost 15% of all Main Belt asteroids should be within 60° of Ceres at any given time and remain there for fifteen years or longer before drifting ahead or back out of range. Some asteroids will “fly in formation” with Ceres for centuries. Two target groups suggest themselves: the “out-fronts” ahead of Ceres but in slower larger orbits, and the “in backs” behind Ceres but in faster smaller orbits. At any rate, access to 15% of the Belt should do us well for quite a while. To compliment Ceres as regional centers, 210 km wide #88 Thisbe (1415 years to drift 120° with respect to Ceres) and 163 km wide #39 Laetitia (3540 years to drift 120°) might serve.”

A Xity on or at Ceres could be a communications and education center. It could be a processing and refining complex as well as a warehousing center where small loads of this and that could be cached for eventual co-op shipment to various other locations. It could also serve the many neglected social needs small scattered bands of asteroid pioneers will have. [For one scenario of asteroid settlement see MMM # 35 MAY ‘90 p. 3. “PORTS OF PARDON” MMM Classics #4].

Route-plying supply and service ships could play a supporting role and these could eventually take on the trappings of nomadic Xities in flight. [see MMM #35 MAY ‘90 pp 6-7 “TEA & SUGAR” MMM Classics #4].

Salient differences between xities at Belt range and those closer to the home planet: Energy Considerations

These differences loom large and will affect city plans and architecture radically. First, while the full suite of minerals and volatiles available to Belt city pioneers from which to build their habitats and support themselves will offer a first glance advantage, upon closer inspection, we find that belt locations will present some energy supply problems in that some of the easier options for lunar and cislunar cities will be denied them. First, the asteroids will be less richly endowed with **Helium-3** than is the Moon, by the inverse square of their mean relative distance from the Sun, (the Solar Wind is both weaker and thinner) and possibly by the relative youth of asteroidal surface regolith in many instances.

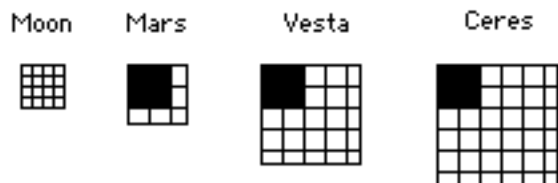

RELATIVE SOLAR COLLECTOR SIZES NEEDED FOR IDENTICAL TYPE COLLECTOR ARRAYS

And by the same inverse square of distance ratio, they will need that much more collector area to harness available **solar energy**. At the range of Ceres, 7.67 times as much collector will be needed to produce the same amount of electricity as the same type collector on the Moon or in Earth orbit. For solar energy users, this disadvantage will put a definite premium on cost-be-damned ultra efficient collector designs

For Belt cities, the need for adequate energy supplies will be especially critical. Such **food-exporting** settlements, feeding and provisioning not only themselves but a relatively more numerous dependent “rural” population of prospectors and miners as well, will need excess power (by Earth-vicinity/Lunar standards) for agriculture, processing & manufacturing.

A consolation prize may be that much less attention may need to be paid to **radiation arrays** to carry away excess heat produced in the city. The ambient environment will be significantly colder, providing much more of a heat sink.

Nuclear power, fission and fusion (probably with Helium-3 purchased from the Moon), will be more attractive for both backup and baseline needs. *Building a Belt city will be a much more demanding and expensive proposition.*

Gravity Considerations

Providing a physiologically minimum level of **gravity** (our suggested 1/6th G “Lunar Standard”) would seem to limit Belt cities to free orbiting constructs: sphere, torus, cylinder, or helix types that can provide the semblance of gravity against their out-facing hulls through rotationally induced centrifugal force. Cities of these types could be independently orbiting within the Belt, or in orbit about major asteroids.

For example, a city 486 miles or 782 km above the surface of Ceres would orbit in synch with the terrain below and could easily be tethered to it or physically joined by a coaxial elevator system. (Placing the city just slightly higher would supply the “counterweight” needed for such an elevator.)

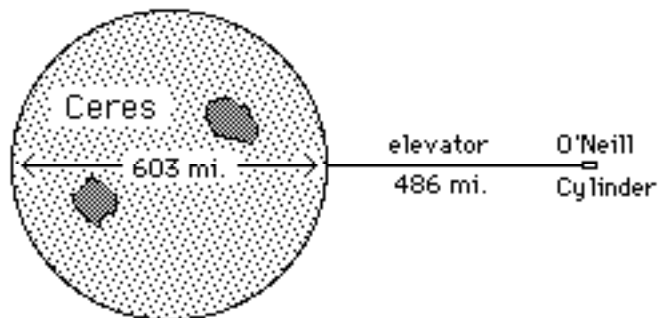

LOCATION of a hypothetical O'Neill Cylinder Space City “Piazzini” (city scale exaggerated) orbiting Ceres in synch with the asteroids rotation at a distance of 1.38 radii above the surface to which it is further physically locked by a cable-conduit-elevator system. At this distance from the Sun, solar power collectors attached to the cylinder may be impractical and power, either from extensive surface solar arrays or nuclear plants may be piped up by conduit. This frees the cylinder to orient itself so that its axis points at Ceres. The asteroid and tethered city system, rotates every 9.08 hours. A date cycle of 8 periods per 3 dates would give dates 24 hrs. 12.8 min. long. *Commutes to the surface may take about an hour each way.*

But *what if* it is desirable to have **surface cities** on the asteroid itself? Gravity on even the largest asteroids is very “slow”. At a maximum 3 hundredths of a G on Ceres and Vesta, asteroidal gravities are sufficient to keep *undisturbed* items in place - period. Such “mini-g” levels are likely insufficient to support most gravity-assisted physiological processes. The human body might as well float loose in freefall.

The “**gravitrack**” might be an answer. As much of the settlement as practical could actually “ride” a steeply banked mag-lev track to produce the centrifugal force desired. A variably banking transfer vehicle on a side rail would accelerate to meet, then dock with such a “train-city”, then undock and decelerate to dock with surface-stationary facilities. Alternately, the whole train-city would periodically spin down, then back up, say every eight hours, to let people on or off. However this simpler access option would either present some major problems in emergency situations if schedules were adhered to, or result in frequent general chaos if they were not.

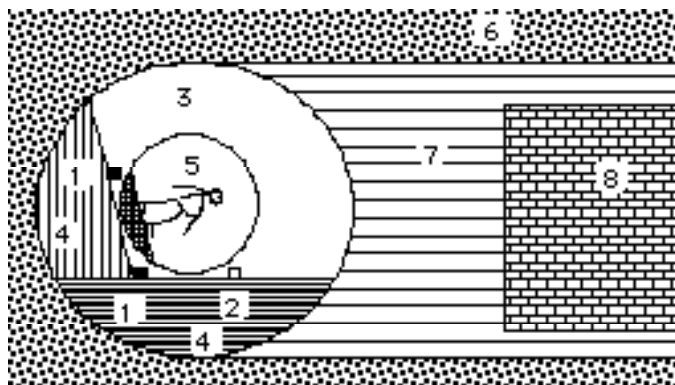

CRUDE SCHEMATIC OF GRAVITRACK SECTION:

- KEY: 1 banked mag-lev rails; 2 safety rail
- 3 tunnel cavity ring of mag-lev train-city
- 4 support work for mag-lev rails
- 5 mag-lev city habitat etc. showing effective nadir
- 6 rock and soil; 7 torus of tunnel
- 8 stationary mini-g environment buildings at center

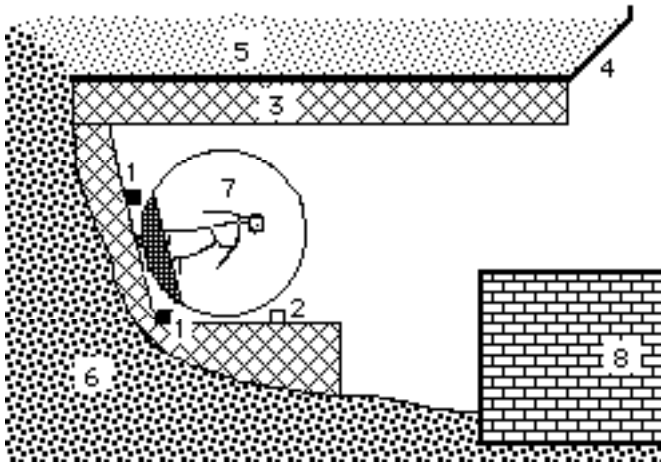

ALTERNATE MAG-LEV XITY SCHEME: Banked track (1, 2) is situated inside the lip of an appropriate-sized crater. 3) Space Frame support for shielding shed; 4) shed retainer; 5) regolith shielding; 6) crater bedrock; 7) mag-lev torus section module; 8) surface-stationary mini-g xity facilities in middle of crater.

We've already suggested that such a ground-based artificial gravity system form the heart of facilities on Phobos, riding the lip of the 5km/3mi wide crater Stickney on an 89°+ banked track at 307 mph (once around in just under 2 minutes or 1/2 rpm) to simulate Mars' 0.38G. [MMM #6 JUN '87 "Mars, PHOBOS, Deimos" -MMM Classics #1.]

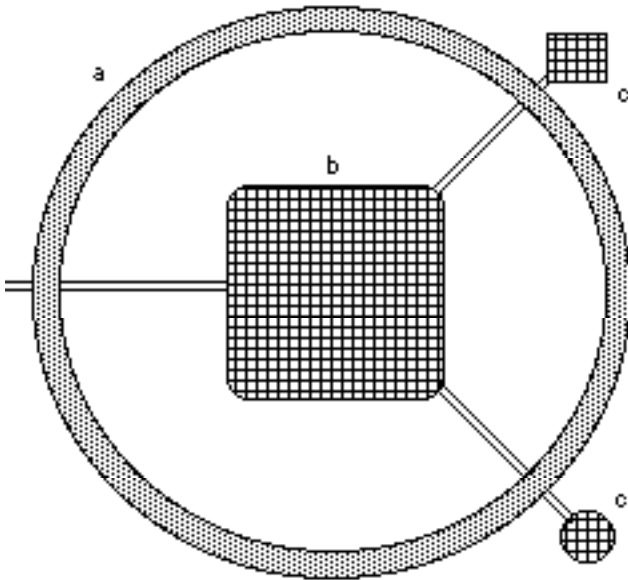

ASTEROID SURFACE XITY showing a) banked circular Mag-Lev track in tunnel or under shielding shed (along lip of crater?); b) surface-stationary mini-g facilities in middle of complex (or crater center); and c) outlying surface-stationary facilities with linking people and cargo trafficway tunnels.

Living in a "part time" gravity-polarized environment will not be new. Those living in "classical" space settlements but working "outside" building new solar power satellites, new space settlements, or running zero-g processing facilities will have pioneered the way. It may be possible to place most residential, recreational, commercial, and office space on such a gravitrack or "nadirrail" even if manufacturing and surface activity functions must be surface-stationary.

If one experiences weight only during sleep time, the

benefit will still be appreciable for physiological, if not muscular, health. Recent experiments with bed rest have led investigators to suspect that periodic doses of gravity will prevent much of the physiological deterioration (reduced blood volume, fluid and sodium loss, decreased aerobic performance) we've come to expect of negligible-G.

Shielding needs will be slightly reduced. Cosmic radiation exposure will remain the same, and as on the Moon and Mars, surface settlements will have the built-in advantage of having their backsides covered, of having to shield against only one half the sky - above the horizon. Vulnerability to Solar Flares will also be reduced. Unlike the case on the Moon or Mars, however, the "weight" of the shielding overburden will not significantly compensate for the upward and outward structural stresses caused by normal pressurization.

"Solar access" by mirrored light pipes following a broken path to preserve radiation shield, or by fiber optics will provide less of a psychological boost at these distances from the Sun, simply because the sunlight is so much less intense (about 1/8th of Earth/Moon normal at Ceres, 1/5.5th at Vesta). Public areas of simulated "full-strength" sunlight provided by *intense* over-illumination, e.g. by a ceiling *packed* with fluorescents or the equivalent, would prove popular in park and garden settings, places of refuge from daily routine and fatigue.

Xity Construction Materials: When it comes to materials for construction and furnishings, Belt Xities, as those on Mars, will see a return of the "volatiles are free" days of old Earth, unlike the "harsh mistress" situation for early Luan settlers and those in near-Earth space xities while still dependent primarily on lunar-sourced materials. There, volatiles must be, to all intents and purposes, "rented" by the hour, so to speak, to insure the maximum circulation and minimum banking of scarce, "exotic" lunar-deficient elements (H, C, N).

As on Mars, the Belt xity's farms will also raise crops that yield wood and chemical feedstocks for plastics and synthetics. Indeed, it may be out here in the Belt that a new breed of construction materials is developed: **cryo-plastics**, [our word coinage] offering superior structural performance without characteristic brittleness in extreme cold.

Such materials, *if* they can indeed be developed, may become critical if and when humanity moves out to the moons of the outer Solar System: Callisto, Ganymede, Europa, and Io around Jupiter, Iapetus and Titan around Saturn, Oberon and Miranda about Uranus, Triton about Neptune, even Pluto and Charon. In all these places the tables will be turned. Ices and other volatiles serving as chemical feedstocks will be relatively abundant, rock-bound silicates and metals relatively scarce - at least by past human experience. It may be in the R&D labs of some future Ceres chemical plant that the seminal brainstorming is done about "in situ" architecture (relying on locally produced materials) for self-sustaining settlements on the strange and exotic "cold hydrocarbon soup" world of Titan.

Xities serving asteroid miners will first arise near to home, then out of sheer logistic necessity follow human trail blazers out into the Belt itself - all in support of a full range economy of mineral wealth to support an enhanced and shared standard of living on a cleaner, greener Earth.

Along the way, new challenges to the viability of the xity will need to be met and mastered. These include the increasing dimness of ambient sunlight, supply lines and resupply lead times stretched to the limit, the natural availability of only mini-gravity, and the steadily increasing cold.

The later is not only a challenge to xity architects and engineers wishing to design for thermal equilibrium. It also poses a challenge to mining engineers on worlds where water-ice acts as a stubborn cement for fractured rock and regolith. That same ubiquitous permafrost could be a problem for surface or near-surface settlements. In the learning process the foundations will be laid for taking humanity's next step, breakout into the vaster, richer outer Solar System. **MT**

An Alternative Moon Buggy

Internal Combustion Engines for Lunar Surface Transport with powdered metal serving as fuel.

by Michael Thomas, Seattle L5 Society

Eccentric automobile designers have through the years built cars that run on a wide variety of fuels, from alcohol to manure. One designer has built a car that is fueled by left-over grease from the deep frying vats of fast food restaurants. But the design that most startled me when I learned of it, is an automobile engine that is fueled by powdered coal. I never before imagined than an internal combustion engine could burn a solid fuel.

I do not advocate coal-cars, as they would be polluting, but solid fuel opens a whole new world of possibilities. It is not so surprising really if you think about it. How many times have you heard of a grain silo exploding because wheat dust reached explosive concentration and was ignited by something. And while "flour power" may not be the answer to dependence on oil, there are many powders that will burn.

The Moon is very rich in certain elements, most abundant of which are oxygen and silicon. Silicon combines with oxygen (burns) to form silicon dioxide, glass. Many lunar materials are silicates, and silicon could with effort be separated out and processed into a fine powder. Once powdered it could be injected into an engine's combustion chamber along with some liquid oxygen, then ignited with a spark.

Other elements abundant enough on the Moon to consider are aluminum, magnesium, titanium, and potassium, in that order. Separating aluminum from ore requires vast amounts of electricity, so it may not be the best choice, even though it burns well.

On Earth, titanium is far too rare and expensive to use as a fuel, but on the Moon, in some areas, it is more abundant. It also requires somewhat less energy to separate from ores than does aluminum. Export potential might make titanium valuable on the Moon, something one would not waste, because it can be sold for money or traded for other elements, like carbon and nitrogen, which are scarce on the Moon. But burning titanium as a fuel on the Moon would not really waste it.

Because the Moon has no atmosphere, burning fuel there could not cause air pollution: there is simply no air to pollute. So where would the exhaust ash from such an engine

go? It would simply fall to the ground, where it would remain indefinitely. And while this titanium dioxide (or other metal oxide -- there is a significant amount of unoxidized iron fine particles in the regolith) dust on the road surface and vicinity reaches some predetermined concentration or depth, it could easily be recovered by a surface skimmer of the sort used in regolith mining and processing. The metal and oxygen could then be separated and once again burned as fuel. Because of the ease of recovery, this would be a renewable, reusable fuel. Very little would be lost or wasted in the long term. Fuel use would increase only with increases in population and economic activity. Because of the renewability of powdered metals as fuels on the Moon, mining operations would not have to support a constant demand for fuel. Only a small fraction of their powder would be diverted for use as fuel. Most of it would remain for use in domestic industries and for export to Earth or elsewhere.

Another potential fuel, potassium, has the unique property of self-igniting on contact with water. But it is also easy to ignite in the presence of pure oxygen. Since metals burn at high temperatures, igniting a metal dust fuel may not be as easy as igniting a flammable liquid. Of the metals available on the Moon, potassium will ignite most easily and at the lowest temperature, which may make it ideal for a metal dust engine. Magnesium also burns well, once ignited, and its abundance in lunar highland rocks is around eight percent.

One drawback to a metal dust engine is that metal dust burns at very high temperatures compared with more traditional (liquid or gas) fuels. And in the Moon's airless environment, cooling such an engine would be difficult. Some of the engine's heat could be used to heat and vaporize the oxygen just before it is injected into the chamber. And if the vehicle were to carry more LOX than it needed to oxidize all of its fuel, some could be routed through the engine block, where it would be heated and vaporized, then released, carrying the heat into the lunar vacuum. Even so, the engine would likely run very hot. Possible solutions to this problem include the use of a titanium engine, possibly with ceramic coatings.

Unlike electric vehicles, they would not be dependent on solar energy for re-fueling that is available only 50% of the time. (While electric vehicles could operate during the long nightspan, they would likely limit their activity to the use of a single charge of their batteries, due to power limitations when the solar grid is down.)

Metal dust engines have other possible uses, such as driving generators for emergency or supplemental power during the nightspan when solar energy is not available. They could also be used to drive heavy equipment and industrial machinery where large amounts of electric energy are not yet available. **<MT>**

**Astrology is to Astronomy as
A Drug House is to a Drug Store
*alternately***

**the astrologer is to the astronomer as
the "candyman" is to the pharmacist**

MAILBOX

[EDITOR: The whole purpose of MMM is to spur thinking on the part of our readers, *and hopefully* followup investigative and research and demonstration activities. We've gotten a slew of interesting mail of late and we'd like to share some of it with you. Great Reading! - PK]

Andy Reynolds On Mars Meteorburst communications and alternatives:

I read the "Mars Special" issue [MMM # 54 APR '92] and had a few ideas that I thought I'd pass along to you.

The idea with the meteor scatter communications package is one I wouldn't bet on. Mars, with its thinner atmosphere, is going to make getting it to work difficult. This thinner atmosphere means that it doesn't extend to as great an altitude as does Earth's.* Because of this, a meteor will be much lower before it begins to generate a strong enough plasma sheath off which to reflect radio signals. This would limit maximum range of any such system.

[* EDITOR: I dispute your premise. While the atmosphere is thinner, at Mars' surface equivalent to that 125,000 feet above Earth's surface, Mars' *gravity* is *also* significantly less, 38% of ours, and the *rate* at which atmospheric density falls off with increasing altitude is lessened. In short, Mars atmosphere is *less tightly packed* than ours, and in fact its total depth is, believe it or not, *much* greater than ours, there being significant traces some 600 miles above the surface. Given this, I'm not quite convinced your pessimistic conclusion should go untested. PK]

[**Reynolds, cont.**] There are alternatives, however, to the use of meteor scatter. One would be a series of remote stations designed to receive and re-transmit signals from settlement to settlement. Located on natural high spots as the Olympus Mons area, such a system of repeaters would be capable of providing solid, reliable communications with only minimal development and placement costs.

[EDITOR: A crude non-electronic version of such a "smoke-signal" system was first pioneered by the Koreans about 600 A.D., allowing transmission of messages throughout the peninsula in a matter of an hour or so. It is important to remember that Mars is a smaller world with closer horizons and that horizon-extending highs such as Olympus Mons (75,000 ft or more) are uncommon. There are many areas where repeaters would have to be placed every 4 or 5 miles. While those opening new territory could mark their route with such stations, the need to do so might not be a welcome burden. PK]

[**Reynolds, cont.**] Another option is to deploy communications satellites that are either part of a precursor mission probe, or that 'hitchhike' along with one. In the former case, [it] could be designed as a separate unit, having independent power and control

systems, allowing it to survive all but a massive failure of the primary satellite. The alternative would have the 'hitchhiker' simply ejected into a Martian orbit by the primary probe. With the work that has been done on microsats of recent, it should be very possible to construct one or more that could ride along with a survey or other craft destined for Martian polar orbit. This would allow the emplacement of a fairly capable "store and forward" type communications network at a very modest investment. A more versatile system might feature slightly different satellites that are dropped off in an orbit that is highly elliptical and also inclined. This sort of "Martian Molniya" orbit would allow settlements very far apart to communicate real-time for a very long period with little or no antenna pointing.

Yet another option is to make a multi-function satellite that might serve communications, weather system tracking, and teleoperations. A final option might be emplacement of communications packages on Phobos and Deimos, eliminating the need for attitude control systems and support structures for solar arrays. Meanwhile, I've sent out a message [on the nets] asking for opinion from the amateur radio meteor scatter folks and I'll pass along whatever I find out.

[EDITOR: Thanks, Andy. I'll be anxious to hear what they have to say. Meanwhile, I am well aware of all the conventional options you mention. My point in suggesting that we go ahead with a Mars Meteorburst Experiment is that it could leave pioneers with a more self-reliant fall-back system, something they could more easily self-manufacture on Mars, should continuing support from Earth to maintain a satellite network wane. I hail from that radical line of space dreamers who feel that *our work is not done until space-based civilization can continue on its own no matter what happens on Earth, whether support from the home planet ends with a bang, or with a whimper* - as is more likely. I also think the more realistic scenario of Martian settlement is not a planned and budgeted effort directed from Earth but a rebellious refusal of explorers sent on limited tours of duty to return home when their tours are finished, i.e. settlement decided and directed by would-be permanent Martians on Mars. Perhaps this seems romantic. My concern is to make it less so, i.e. more realistic, by whittling away at the long list of umbilical cords that might conceivably have to be cut, hopefully temporarily, to enforce the "New Martian Order." If that sounds silly, I don't apologize. And ditto for *Lunar Settlement*. PK]

Andy Reynolds On Mars Skimmers:

[**Reynolds, cont.**] I thought about the skimmer too. I think that it would be better if the design can have sufficient lifting gas capability to make the skimmer effectively weigh zero, having neutral buoyancy when it's unloaded. This will reduce the load that the fans and skirting have to support, allow them to be far less massive, as they only need to lift the weight of the cargo, fuel, and personnel on board. With this system, the control of lifting capability is fairly simple, as all that would be needed would be to reduce the thrust the lifting fans are supplying. As for a power source, how about CO/02 cycle

engine driving a generator, which in turn powers the lifting and driving fans? This would allow the engine to be run at maximum efficiency while providing the maximum control over the way that power is used. Electrical motors are very efficient, as are most modern generator designs and power distribution and control electronics. I've enclosed a (very) rough drawing of what such a skimmer would look like. Hardly a slick, fast machine (more like one of those Navy LCAC's), but simple and easy to reproduce.

SKIMMER: CHASSIS TOP VIEW

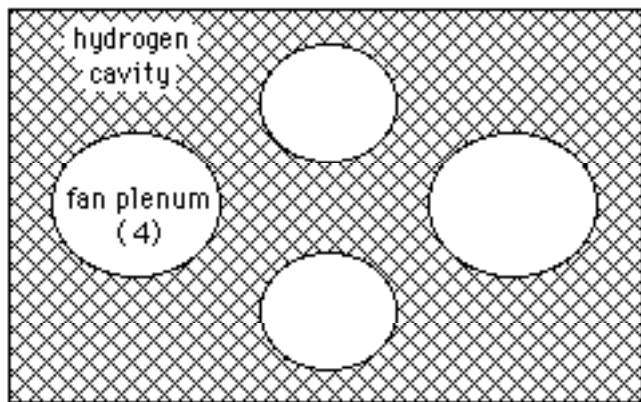

SKIMMER: CHASSIS SIDE VIEW

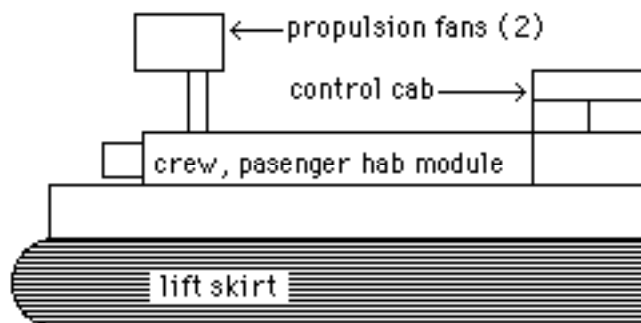

Skimmer notes: hydrogen lift MUST BE equal to total weight of vehicle without cargo or personnel on board. Fans are needed to lift only excess weight.

SKIMMER OPERATION:

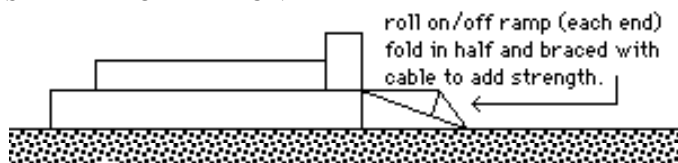

Andy Reynolds On the Mars Permafrost Explorer:

[Reynolds, continuing] The Permafrost Explorer idea might have some problems. The conditions under which permafrost exists on Mars are very different from those present here on Earth. This might limit the amount of use an Earth-based 'ground truth' calibration might be. With the thinner atmosphere, permafrost on Mars is likely to lie much deeper than here on Earth. [shallower deposits would sublimate, Ed.]. It might be possible to some sort of probe that looks for several different "indicators" at once and adds them all up to say "Permafrost here!" The problem is that getting all of these instruments (SAR, IR scanning camera, visual imager tuned to stray water

vapor, etc.) onto one platform won't be cheap or small. Will think on it some more....

Andy Reynolds On Mars Microbot

Lavatube Explorers:

[Reynolds, continuing] Preliminary idea for the "microbot" you were talking about. There has been a lot of research into superfine optic fibers in the past few years. These fibers are very light weight, fairly strong and most importantly, can carry very "broad-band" type signals like TV images/ Using your idea of a "mother" lander that would carry the rovers to the general area of the lavatube opening, the idea would work something like this. Each rover would carry a spool of, say, a couple miles worth of optic fiber on it. This would weigh a couple of pounds, and shouldn't burden the robot too much. The end of the fiber run would connect to the lander. The lander in turn would relay the data and images collected up to an orbiting craft or directly back to Earth.

As each rover is released, it would simply spool out fiber optic cable behind it, sending back information as it goes. If the data link is made two way, it might be possible for the lander to relay commands back to the rover to stop and look at something it had seen that the lander's computer deemed more "interesting". This set-up would allow a single lander with say half a dozen rovers to explore and map a fairly large area.

One fault in this scheme might be that the lavatube might not be branched, i.e. it could form a single, linear feature. In this case, it might be advisable to have an alternative approach, say where a rover would first explore the entrance of the tube, determine its initial structure (linear, branching, both), then have the lander select how it could best use the rovers.

In this situation, the rover cable connector might be disconnectable, allowing for one rover to follow a tube to the end of its tether, then have the lander command a second rover to follow it, but with the optic cable disconnected. In this mode, the rover would simply contain the memory of how its sibling had navigated to get to where it was, find the first rover, then plug in its cable to a receptacle on the first one. This would allow it to continue down a long tube, exploring and mapping it in a "relay team" approach. Neither the hardware nor the software for such an approach should be very difficult.

Alternate approaches, such as using radio or lasers to relay data and images, run into inherent problems with unexpected changes in transmission qualities (due to changes in the wall make-up, sudden bends in the tube or other obstructions) that would mean adding increased processing and navigational capabilities to the rover (i.e. remembering when and where the last reliable communications with the lander was and figuring out how to get there). Not pretty, but a start. Well I see I've run on for a bit so will cut short for now. Will think on things some more and see what all else I can come up with. Good reading, like "Moon Miners", helps the process!

Andy Reynolds
Rochelle, Illinois

On Windows in Lunar Xity Skyscrapers.

I have a question for you. How can you have windows in Moon structures with all the debris zipping through space? I see that your illustration [SKYSCRAPERS on the Moon, MMM # 55 pp 5-6 MAY '92] that the openings are to horizon views only, but even so there are tangential paths that could be tough on windows. And direct sunlight also would be something to be avoided, probably by choosing the latitude of the site.

Dick Linkletter
Bremerton, WA

EDITOR'S REPLY: Assuming a non-polar site, only horizon-hugging windows to the East and West would get direct sunshine. This can be handled either by not having windows in these very directions or by suitable automatic shuttering at the appropriate times (sunrise and sunset dates).

As you can see from the illustration in the SKYSCRAPER article, the windows are set well back several feet in horse-blinder openings through the shielding so that the field of view is quite restricted. This not only would allow openings to the ESE, ENE, WSW, and WNW but also restricts exposure to incoming surface tangential meteorites to just that portion coming nearly head on.

Nonetheless a significant if diminished danger does exist and this vulnerability must be addressed. I would suggest that in addition to multi-paning with graduated pressurization between the panes to handle the full inside pressure to vacuum differential, that a free-standing removable and replaceable fore-pane of shatter-resistant optical quality glass-glass composite be used. This bumper-pane, physically separate from the sealed window unit proper, would absorb almost all micrometeorites and could be replaced when pitting begins to interfere with vision.

Space debris is confined, fortunately, to low Earth orbit. Anything near the Moon is quickly purged from the environment by the significant lunar gravity. The chances of something getting by the bumper pane and penetrating all the window panes proper are not significant within the expected lifetime of the building. Sooner or later a window-invited meteorite decompression *will* occur, but it will be properly seen as a freak. If one or more panes are fiberglass reinforced, as suggested, the leak rate should be slow enough to allow escape and/or hasty repair and/or automatic pressure-drop-triggered plugging.

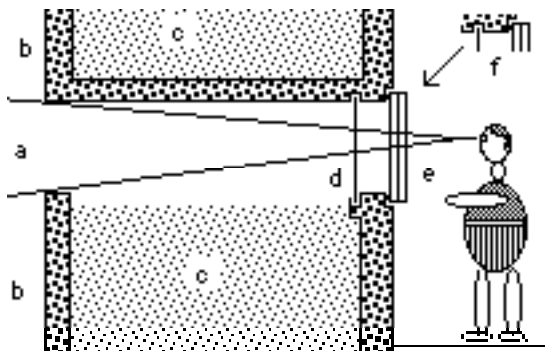

KEY: a) restricted field of view enforced by shielding set-back = restricted vulnerability both to cosmic radiation and micrometeorites; b) shielding retainer structure; c) regolith

fill for shielding; d) visual quality shatter-resistant easy-in/easy-out micrometeorite bumper pane; e) sealed multipane unit; f) detail of window unit blown up, next illustration.

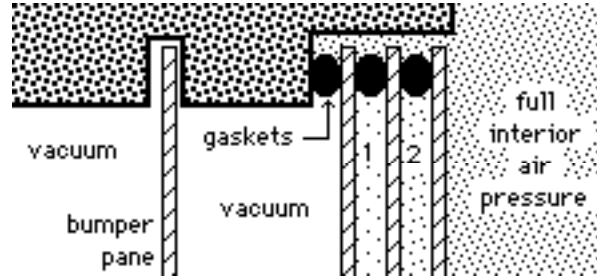

KEY: 1) = 1/3 interior pressure; 2) = 2/3 interior pressure. This stepped pressure system relieves stress. The gas between the panes could be something other than air such as argon harvested from the lunar regolith. The sealed multipane unit is fastened in place simply by the graduated air pressure increases on the continuous perimeter gaskets.

I would be much more worried about exposure to cosmic radiation even from the very restricted portion of the sky accessed by such windows. I certainly would not design a direct-path window (as opposed to a broken path or periscopic one) in a residence. I included them in the design of possible lunar skyscrapers only in the intention that the pattern of use of such buildings, or of the rooms endowed with "windows", be such that the accumulated exposure of any given individual be within tolerable limits. Lunar pioneers may all have wrist or necklace accumulative "rad monitors" that will tell them when to tighten up their exposure patterns. **PK**

MMM #59 - OCT 1992

A Place for Humans in the Outer Solar System?

Last month we sketched how Xities Serving Asteroid Miners might eventually follow this hardy corps of rugged individualists out into the Asteroid Belt itself. What might be the economic rationale for going out even further into the dark and cold of the Solar System? What obstacles must be overcome? Three articles on the opportunities, challenges, and Xities of the Outer Solar System:

[Series Continues]



Pronounced KSIH-tees, not EX-ih-tees
[Human communities beyond Earth's cradling biosphere]

Economic Opportunities in the Outer Solar System

Resources for Local Settlement Consumption

By Peter Kokh

While taping the resources of the gas giant planets themselves may seem a formidable challenge, for settlement purposes, those resources available on the many outer system moons should be enough in most cases to support self-sufficiency. Whether or not such resources provide a basis for competitive export of materials and products to trade for those items which must, at least initially, be imported from the inner system worlds (Earth, Moon, Mars) is another question. Unlike the volatile impoverished Moon, with the exception of volcanically hyperactive Io, most of the larger satellites of Jupiter, Saturn, Uranus, and Neptune hold ample quantities of both metallic silicates and volatile ices. Settlements on any of these worlds would not have to import major tonnages of raw materials. Lesser amounts of some metals strategic to advanced technological civilization may need to be brought in at first until economically recoverable local lodes can be identified.

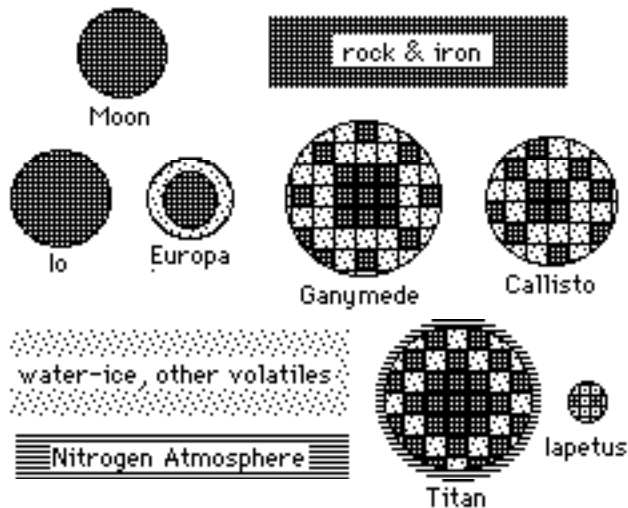

SIX IMPORTANT SATELLITES OF THE OUTER SYSTEM shown with the Moon for comparison. Jupiter's Galilean quartet is a varied mini solar system in its own right. Sulfur spewing hypervolcanic Io has long since purged any volatiles it may have once had. Europa has an ice crust surface probably hiding a hundred km deep ocean of water. The "calico twins" of Ganymede and Callisto have rocky iron cores with mantles and crusts of mixed rock and ice. The same holds for Saturn's great satellite, Titan, which however has a Nitrogen atmosphere half again as thick as Earth's laden with hydrocarbon soup clouds covering a surface of rock, ice, methane ices and slushes, and possible hydrocarbon 'tar' pits, lakes, and seas.

Exportable Resources: Energy Stuffs

However, development of volume exports *IS* the question, and without this, settlements in the Outer System will be hard pressed to survive, let alone thrive. All four of the Gas Giants, happily, contain significant atmospheric resources that, if not strictly inexhaustible, will serve us well for many centuries at foreseeable rates of growth in demand. The rock and metal cores of Jupiter, Saturn, Neptune, and Uranus - while each quite a bit larger than the whole globe of Earth - make up

only a lesser fraction "seed mass" component of their entire bulks. The rest is predominantly Hydrogen and Helium salted with methane, ammonia, and other gasses and cloudstuffs.

As fusion power, primed with the Helium-3 endowment from the Solar Wind 'sponged up' by the powdery lunar regolith 'topsoil' over the preceding billions of years, becomes ever more and more the vital wellspring of our advancing circumsolar civilization, the vastly greater reserves of this rare isotope available in gas giant atmospheres will become the Klondikes of centuries to come. Such mining will not be a simple scooping affair.

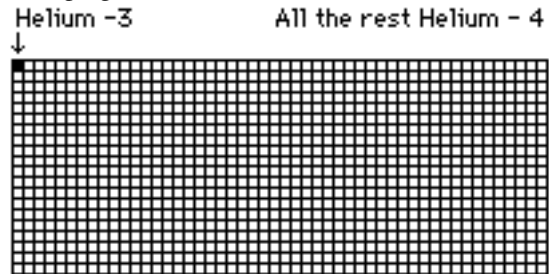

"HELIUM" must first be separated from the atmosphere by freezing out the other gases, then the small amount of the Helium-3 isotope must be separated from everyday Helium-4.

Intuitively, the first place to go would seem to be Jupiter, both because it is the closest and because, being most massive, it contains easily the greatest reserves. Counter-intuitively, instead **we will head for distant Uranus**, both because it lies in the shallowest gravity well of the four giants, and because its planetary history seems to have left it with the least homogenized atmospheric soup.

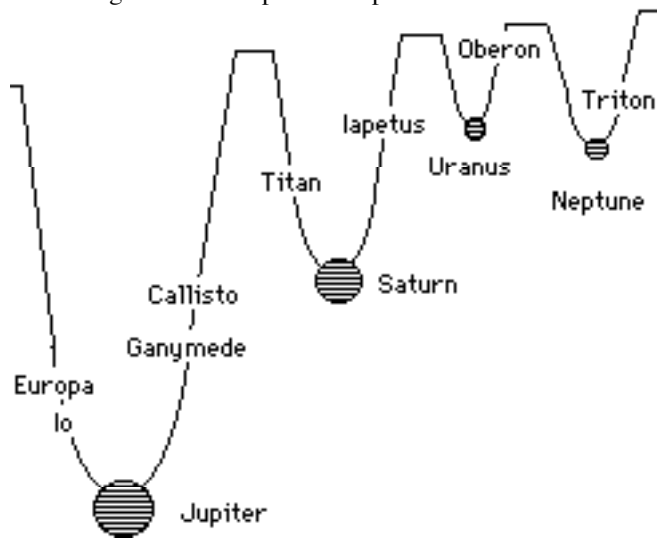

OUTER SOLAR SYSTEM GRAVITY WELL HANDICAPS. Uranus is easily the most economical source of resources common to gas giant atmospheres, such as Helium-3.

Once a "pipeline" of LHe3 tankers, likely uncrewed drones, is in place, the greater distance will be no more of an obstacle to supply than is the greater distance of Kuwait or Prudhoe Bay as compared to off-shore Texas or Louisiana. Outpost settlements will be needed somewhere in the Uranian system for maintenance of the fleet and teleoperation of the Helium-3 recovery systems. If it proves more economic to send loaded tankers on one way journeys inbound, i.e. if reusing

them means sending them back out empty at a greater expense than building replacements, there could arise a significant tanker manufacturing enterprise on one of Uranus' major moons. We predict this will indeed prove to be the case.

How big of a settlement outpost will be needed? It will have to manufacture a steadily increasing number of tankers per year to keep the "pipeline" flowing to Earth and other population centers in the Inner System. Those involved in this manufacture will need to be supported by miners, farmers, and producers of other products needed to keep the settlement self-supporting in a major way. Even with automation, we are talking a few thousand pioneers in due time.

Operations in the Uranian System will be tricky because of the skewed equatorial plane of the planet, shared by its moons. Uranus' axis is tilted 98°* to the general plane** of the Solar System. (* Astronomers say 98° rather than 82° to show that the direction of rotation of Uranus and of the orbital motion of its satellites about it, is retrograde or clockwise, the opposite of the Solar System norm). (** We now define the "ecliptic" as the plane of Earth's orbit about the Sun. This chauvinism will in time be replaced as we recalibrate everything with reference to the plane of Jupiter's orbit wherein lies 74% of the angular momentum of the entire Solar System, Sun included!) A ruddered aerobraking maneuver in the outer reaches of Uranus' atmosphere will allow us to make moonfall in this side-rolling equatorial plane.

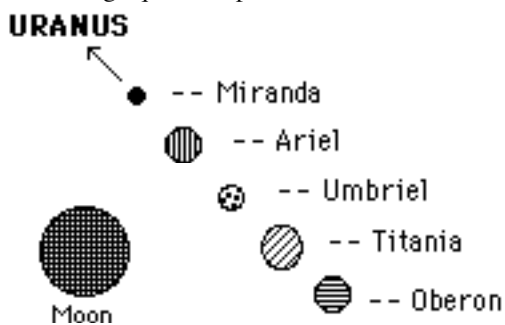

DIAMETERS, DISTANCES FROM URANUS, & TELEOPERATION TIME LAGS

	Size*	kilometers	secs
Uranus-Miranda	550	130,500	0.87
Uranus-Ariel	1500	191,800	1.28
Uranus-Umbriel	1000	267,200	1.78
Uranus-Titania	1800	438,400	2.92
Uranus-Oberon	1600	586,300	3.91
(Earth-Moon)	3476	376,284	2.56

KEY: * diameter in thousands of kilometers. **Miranda** is highlighted because it is the closest moon of size and offers the shortest, easiest time delays for teleoperations. **Ariel** is highlighted because in addition to offering short lag times, it is a moon substantially larger and more massive than Miranda. **Oberon** is highlighted because while its teleoperation lag is barely acceptable, its very distance from Uranus places it on the shoulder of the gravity well, making it the easiest moon to reach from Earth. Earth-Moon stats are shown for comparison.

OBERON-MIRANDA and OBERON-ARIEL

window every	1.58 days	3.10 days
trip time lasts	6.43 days	7.28 days
send-receive lag	3.04-4.00 sec	2.63-5.18 sec

**Exportable Resources: Terraforming Materials
H₂O from HYPERION, N₂ from TITAN**

Many space dreamers inspired by Freeman Dyson and Gerard O'Neill look upon the outer planets as caches to be dismantled for building materials with which to build a vast ecosphere shell surrounding the Sun and trapping all its energy capable of supporting megadrillions of people (Dysonsphere concept) or alternately innumerable individual O'Neill space settlement structures. But unless you postulate a future ability to transmute overabundant unwanted elements into more useful ones, and or you postulate our development of ways to mine the planetary cores of these giants that lie buried under unimaginably crushing overburdens of hot liquefied gasses or ways to blast into space these massive atmospheric envelopes to lay naked the metal rich cores within, such dreamers are indeed just dreaming. In fact, 80 some % of the total mass of the Outer System is Hydrogen, much of the rest Helium. NOT the stuff of which Dyson Spheres or space colonies are made.

Significantly more humble but *still* involving a collection of development and logistic challenges that could well remain dauntingly out of reach perhaps for centuries, is the wholesale transport of raw materials intended to help "terraform" Inner System worlds like Mars, Venus, Mercury or the Moon. Full blown terraforming is heady stuff. Ambitious schemes to move from one place in the Solar System to another the enormous quantities of volatiles, specifically Hydrogen (or water or water-ice) and nitrogen, will involve efforts on so large a scale over periods covering many decades if not centuries, that it strains the imagination. Someday, we may have the energy and the wealth to reengineer the System to suit our liking. That day would seem far off, and the near term significance for economic opportunity small.

Yet, when the day does come, it is already clear where we might look for the materials needed. There are enormous amounts of water and water-ice in the Galilean moons of Jupiter. There is yet more in the satellites of Saturn. How much is needed? If Earth's oceanic blanket could be removed into space intact, and then allowed to shape itself by its own gravity into a ball thereupon ice-crusting over, it would form a moonlet 1100 km or 690 miles in diameter. If we want to put an ocean even remotely comparable to ours on Mars, we are talking about a lot of material.

It would be easier to get that ice from a small moonlet with negligible gravity than from a more gravid body like Callisto, for example. How about dismantling wholesale Saturn's moons Mimas (392 km) or Enceladus (500 km)? The public hue and cry would be loud: "let them be!"

But further out, orbiting just beyond Titan in a 4:3 resonance with it, is another "right-sized" moon, Hyperion, which *nature* has *already begun* to "dismantle". No longer spherical, Hyperion has suffered from a major recent blow, and with its new "hamburger-like" shape (240x250x400 km), it wobbles about like a top in its orbit. Perhaps we should finish the job. Alternately and less drastically, we could simple whittle it down to spherical size, taking only the form-protruding excess. And if transporting even that much mass to Mars is a forbidding prospect, why not cache this water lode in orbit around neighboring Titan itself for future use?

THE LURE OF HYPERION'S ICE

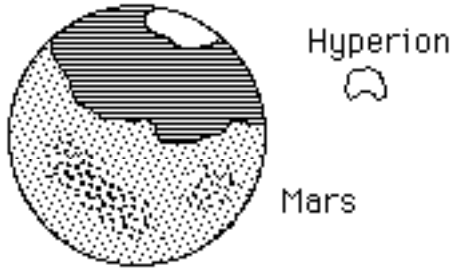

HYPERION'S "MANIFEST DESTINY"? The wobbling, already half-dismantled Saturnian ice-moon of Hyperion contains enough frozen water-ice to fill the Northern Hemisphere Boreal basin on Mars to create an ocean as expansive as the North or South Atlantic with an average depth of 1000 feet. There will be significantly less opposition to "finishing" the dismantling of this moon for its contents than to disturbing any of the other "intact" worldlets.

For Venus, the need is not water, but hydrogen with which to make it from the abundant enough oxygen locked in the planet's very thick carbon dioxide atmosphere. An accompanying stable sink for the unwanted carbon must be found, possibly in the form of some sort of Venus-Sun L1 parasol to lower the amount of incident solar heating. The hydrogen itself could be harvested from any of the gas giant atmospheres.

TITAN'S NITROGEN: - Titan has a hundred times as massive an atmosphere as does Mars. Just 10% of all that nitrogen (i.e. leaving Titan with an atmospheric pressure still 35% greater than Earth's) would raise the atmospheric pressure on Mars 10-fold. One third of Titan's atmosphere (leaving Titan with air pressure *equal* to Earth's) would give Mars a third as much pressure as Earth. And there's enough oxygen in Mars' soil to sweeten that imported Nitrogen breath-fresh.

Will a slow but steady "pipeline" of liquid nitrogen tankers someday begin the transit to Mars? It will surely depend on what effects the loss would have on Titan. If it some-how improves conditions for settlement on Titan, the go ahead may be given. Mars would pay Titan for the shipments with goods and materials needed out there.

Universe Class Tourism in the Outer System

Yet another foundation upon which to build a human presence in the Outer System is tourism. Chesley Bonestel, and other artists since, have given us dramatic paintings of breathtaking sky-filled views of riotously colored, storm racked Jupiter and of Saturn with its rings, both giants viewed from the imagined surfaces of their several moons. But alas, it seems we can't just put all these moons on a tourist itinerary!

The inner three of Jupiter's great Galilean moons - Io, Europa, and Ganymede - lie within the big planet's intimidating radiation belts. And all lie at various depths within the most challenging planetary gravity well in the System.

At Uranus, little Miranda is geologically the most intriguing object in the Solar System. If features a long escarpment with cliff faces 15 km high. Those out that way to "pump" Helium-3 are sure to pay it a side trip. But it is unlikely that even the well-heeled will come out all this distance from the Sun just for a ten-minute long bunjy jump.

Neptune itself is serenely beautiful, if the pictures from Voyager II tell the truth. Its large moon Triton has been

revealed to be a fascinating world. Maybe someday when either time or energy is irrelevant, people will come.

You may have noticed we skipped Saturn, rightly suspecting we've chosen to leave the best to last. Even these days when we know that Saturn's rings are not per se unique and that probably all gas giant planets anywhere in the galaxy have them, Saturn is still the single crowning wonder sight within the realm of the Sun. Its ring system is far and away the most extensive, the most massive, the most intricate, the most colorful, and the brightest.

However, as Bonestel himself realized and brought out faithfully in his paintings, all the moons from Hyperion and Titan on inward lie precisely in the equatorial plane shared by the rings. Standing on one of these moons, you would see Saturn assuredly filling the sky, but would be hard pressed to pick out the razor thin line of the rings themselves, seen edge on. Want close up views of Saturn and views of the rings in open perspective to boot? That's like wanting your cake and eating it too. Actually, tourists *will* see such a sight - en route to or from moonfall and a tourist center.

It turns out that the moon Iapetus is the best place for such a tourist haven. It is the closest moon - if you can call 3.3 million km or 2.2 million miles close! - to Saturn *not* in the ring plane. From its vantage point, on alternate swings above and below the ring plane, the rings (and Saturn's pole and cloud belts) alternately tilt up to 14.7° towards and away from the viewer over the course of Iapetus' 80 day long month (from Earth we can see the rings open up to 26.7°). Happily, even at this distance, some nine times the Earth-Moon gap, hefty Saturn still fills 2° of sky (compare with the Moon's half degree as seen from Earth) covering 12.4 times as much sky and shining less glaringly with 3.8 times as much light as our full moon. The view won't be as spectacular as some of the glimpses en route, but from Iapetus, tourists could watch, photograph, and paint at leisure, tracking Saturn through its phases and moods over Iapetus' 80 day orbital period.

Not only is Iapetus *the* place to make systemfall at Saturn for those interested in the view, it is also quite high up the shoulder of Saturn's gravity well, and is thus the easiest of Saturn's major moons to visit. Iapetus will be the jumping off spot for both tourist and scientific expeditions to the retinue of other moons. There will be sorties outward to remote Phoebe; inward to broken Hyperion, mighty Titan, and to Rhea, Dione, Tethys, Enceladus, Mimas, Janus and several lesser moonlets.

We've already mentioned the potential far future importance of Hyperion and Titan to the terraforming of Mars. And Titan itself will undoubtedly merit the most intense scientific scrutiny. Setting up an outpost on Titan will be very challenging, in current polls right up there behind Mars itself! We predict such exploration and settlement will escalate hand in hand with the strong wave of tourism we've outlined, one piggy-backing on the other as the situation allows.

To get to Iapetus and sibling moons, visiting craft must shed momentum by a dramatic aerobrake maneuver in the upper wisps of Saturn's atmosphere. This will be overtured by a breath-arresting ride over (under) the rings before skimming the lightning-speckled atmosphere on the night side and scooting under (over) the rings on the way out.

Iapetus then, is not only the ideal tourist stop at Saturn, it is Saturn's ideal "Grand Central". To experience such "Universe Class" tourist attractions, once we have a means of reliable, comfortable transportation that can make this "trip of a lifetime" in a routine fashion - even if it takes 3 or 4 years one way - the trickle of tourists will begin.

Thus, while eventually there may be human outposts and settlements throughout the Outer Solar System, we predict *the very first* of these will be on **Oberon** around Uranus, and on **Iapetus** around Saturn. Unfortunately, we won't be around to collect any bets!

"Sun-forsaken" XITIES of the Outer Solar System ... and *Beyond*

"Port Herschel", Oberon

As a center for tended systems and teleoperations to run Helium-3 harvesting aerostats afloat in the atmosphere of Uranus and the transfer of liquid Helium-3 to tankers for the trip Sunward, a settlement would be needed, perhaps on Oberon. But, given the time delays involved, actual teleoperations might be easier from a forward post on Ariel.

The settlement would also do needed repairs and maintenance, have as complete a hospital as practical and manufacture as much as feasible of its own needs. This could perhaps even include manufacture of the Massive, Unitary, Simple components of the tankers themselves, using imported Complex, Lightweight, and Electronic components according to the "MUScle" formula for strategic settlement manufacturing priorities. Thus imports would be held to a minimum, vitally important when it takes a decade or more to fill an order no matter how urgent. The settlement would grow its own food and, logically, power itself with Helium-3 fueled fusion.

An observatory for close up study of Uranus and its moons could be supported as a sideline. In addition, a principal outpost on Oberon would support excursions to the other moons in the system for mostly for scientist but possibly also for a trickle of tourists, drawn principally to Miranda.

Bear in mind that Oberon shares Uranus 98° orbital tilt. The north and south poles alternately point towards the Sun for 42 years at a time. To the extent, given the greatly reduced amount of sunlight, that this is a practical concern, it may be decided to build a pair of polar outposts, one North, one South and switch occupancy and operations from one to the other every 42 years. If just one outpost is to be built, the equator would be the logical site. Oberon's rotation would give it "spring" and "fall" "days" of 13.5 standard days long.

"Bonestel Point", Iapetus

IAPETUS: 1440 km (893 mi.) in diameter.
Surface area 17%L; Gravity 1/20th g (5%).
Escape velocity .67 km/sec (1496 mph)
Day/night cycle ("sol") = 79 d 22 h 5 m = 80 days (40/40)

(a full set of phase changes of Saturn & rings as seen from Iapetus = 1 "Saturnalia")

Saturn-Earth Synodic year 378 days = launch window intervals

Teleop & Communications lag to Titan 15.6 - 32 seconds.

Light trailing (50% albedo)/dark (4% albedo) lead side areas; Craters have been given names from the Charlemagne period.

TRIVIA: In the original 2001 story of Arthur C. Clarke, it was not Jupiter, but Saturn's enigmatically bright/dark shaded moon Iapetus that was the target of the ship *Discovery*.

IDEAL VANTAGE POINT SITE FOR OBSERVING SATURN AND RINGS: 45° E (330°W)(in the bright protected trailing area) and 45° N or S in Cassini Regio. The actual site may be chosen for offering a dramatically scenic Iapetan landscape as foreground for the spectacle of Saturn and Rings.

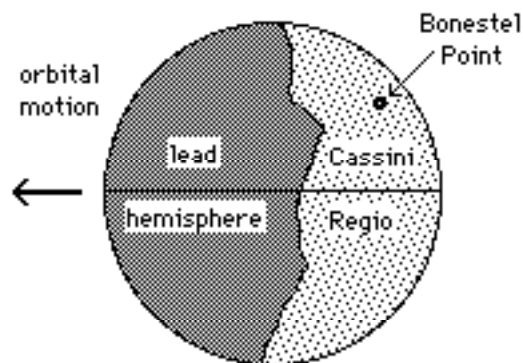

OBSERVATION TRIVIA: Saturn 30° above horizon
Rings open to 14.7° (vs. 26.7° from Earth) tilt to horizon 45°
Apparent diameter of Saturn 2° (4 times apparent breadth of Moon from Earth and covering 12.43 times as much sky)
Full Saturn 3.78 times as bright as full Moon
Ring phases (open, edge-on) precesses full cycle in 7 1/3 yrs.

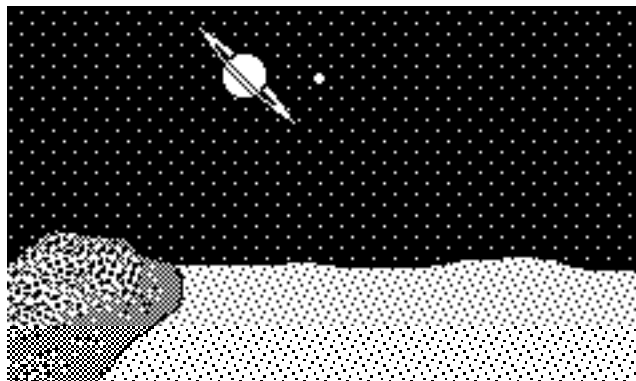

VIEW OF SATURN from "Bonestel Point", Iapetus. Moon at right is our own as it appears from Earth, shown for comparison of apparent size. DANCE OF MOONS: The apparent diameters of Saturn's other moons in Iapetus' sky: Titan 1-7' (The Moon is 29-31' in diameter in our own skies), Rhea 2', Dione 1.5', Tethys 1', Enceladus and Mimas 0.5, 0.2'. Only Titan would ever show an appreciable disk. These moons would all appear in the plane of the rings, to one side or other of Saturn, in front of it or behind.

A Tourist complex on Iapetus would serve as the logical center of operations for all traffic in and out of the Saturnian System. From a sheltered vantage point on Iapetus, tourists and students could observe Saturn and its ring moods and phases through a full 80 day cycle of perspectives as the moon slowly orbits its giant host. Watching the orbital dance of the other 20-some moons would also be part of the show.

There'd be surface excursions on Iapetus and

available side trips to some of the other moons, especially Titan. And, of course, the dramatic arrivals and departures via Saturn itself dashing over and under the rings - front row on the 50 yd line!

As a logistics center for the Saturnian System, the outpost at "Bonestell Point" would outfit expeditions to the other moons and serve as the export/import junction for trade with a trial outpost on Titan. Iapetus might self-manufacture some of its own needs, and some things needed to open Titan.

If an inner moon outpost is desired, 658 mi. diameter Tethys may be a good choice. It has two Phobos-sized (15 mi) natural companions, Telesto and Calypso, in the formation-keeping L4 and L5 positions of its orbit around Saturn.

IAPETUS and TITAN

Iapetus orbits Saturn in a 4:1 resonance with Titan. Minimum energy Hohmann transfer trajectory windows open up for 50 day long one way trips either way between Iapetus and Titan every 20 days. The full circuit communications lag between the two varies from 16 to 32 seconds.

Astrometric Observatory on Iapetus

An Observatory is a must, and tourists might pass time staffing it in assistant capacities. Besides studying Saturn and the other moons of the system, such an observatory could be engaged in a search for trans-Jovian asteroids and comets.

But most importantly, the observatory would be dedicated to astrometrics and stellar parallax measurements, i.e. measuring the position of stars and using triangulation *to determine their distance*. Present parallax measurements use the diameter of the Earth's orbit as a baseline, yielding data of diminishing accuracy out to about 20 parsecs or 65 light years. Here we'd have the ten-fold larger span of Saturn's orbit to compare astrometric positions taken 14.73 years apart (half a Saturnian year instead of the 6 months it takes Earth to get from one point of its orbit to the point opposite).

Instead of the 8,000 stars within the radius now available to our methods, from Iapetus, measurements of equal accuracy would take us out to 650 light years, encompassing 1000 times the volume of space and 8 million stars. Conclusions drawn from this much greater sampling of stars would greatly improve our knowledge of stellar populations. Iapetus would be a scientific springboard for our destiny among the stars!

University of Saturn

A University of Saturn headquartered on Iapetus might play a major role on the long cruises inbound/outbound from the population centers on Earth, Moon, L5, and Mars. Campuses would be established on each of the Earth-Saturn transitel ships. The four year long journeys one way would mean time to burn for both settlers and tourists. Curricula could be custom designed personally for each. Most suitable subjects would be those that are library- rather than lab-intensive.

Courses might include Art/crafts for recyclable media; Performing arts; Literature; Languages; Sciences, especially Solar System astronomy and economic geography, and astronomy of the neighboring stars; Mysticism; Monasticism; Agriculture & Horticulture; Medicine. Curricula intended especially

for prospective settlers as opposed to tourists would be mentor-run and aimed at jack-of-all-trades proficiencies. For practical project and homework, there might well be assignments and projects requested by various settlements.

Given the long cruise times the bane of slow rockets this true University "in" space could offer Baccalaureate, Masters, Doctorate, and Post Doctoral programs.

Besides education, rotation of ship/community chores would have a strong role in relieving boredom as would a full calendar of breaks, holidays, festivals, and other events to be anticipated and prepared for. Brainstorming sessions might be a popular diversion. Shipboard sports might be augmented by carefully supervised "EVA sports" and dinghy races.

"Xenopolis", Titan

NOTE ON ADJECTIVES: Keeping in mind that Uranus has a moon called Titania, "**Titanian**" should be reserved for things and settlers pertaining to that world. To use the same term for things pertaining to Saturn's moon Titan would be misleading. We propose using "**Titanic**" for the latter.

A frontier settlement on Titan would be desirable for several reasons. First of all, a forward outpost there would give biochemists and planetologists a unique laboratory in which to study further the boundary conditions of life on the low temperature end, and offer a glimpse of the primitive reducing atmosphere of ancient Earth. Second, if the settlement effort could be sustained, it would considerably expand the envelope in which human existence is tenable.

For convenience sake, let's christen such an outpost "Xenopolis" (Stranger City) for truly on Titan, humans will find themselves "strangers in a strange land".

Xenopolis' MISSION includes:

1.) Exploration: Titan's geography, geology, meteorology, seismology, economic geography, volatile cryo-cycling in the atmosphere, etc. In support of this effort a unique transportation infrastructure and novel vehicles would need to be developed. A network of remote telestations and tended outposts would support surface excursions for scientists and occasional tourists. "Gateways" (surface ice-free "roads" elevated above graded terrain), hovercraft, and mag-lev rail beds are possible, along with a special family of Titanic aircraft.

2.) Research and Development: to support settlement, we'll have to achieve economic use of Titanic resources: rock, water and methane ices, nitrogen, and assorted atmospheric organic chemicals (Hydrogen & Deuterium, Helium, Methane, Ethane, Acetylene Propane, Diacetylene, Methylacetylene, Hydrogen Cyanide, Cyanoacetylene, Cyanogen, CO₂, CO). Refined "titanochemicals" (cryo-plastics, synthetic feedstocks) will be the buzz word. Export development will be a major goal as will self-manufacture of most of the city's own needs.

"Titanochem Inc." might include surface refineries as well as atmospheric aerostat plants. "Cryoplast Corp." might mill cryo-hardy synthetic building materials; a "Superstable Cryomaterials Laboratories", do advance work in chemistry.

Xenopolis' mission would also include 3) Pushing the Envelope of the Human Ecosphere. How can a community

survive in such an extreme and hostile environment, one so utterly different than any in which we have previously attempted to establish ourselves? Self-manufacturing autonomy using an exotic suite of resources would be a major challenge. Xenopolis would need to produce its own shelter, furnishings, and transportation devices. The xity would be the center for developing habitat and transport systems for ice-rich "cryothermal" worlds. There will be external facilities and outposts that need to be teleoperated. Fuels and power systems that work in the surrounding cold must be designed and tested to unprecedented levels of dependability. Environmental systems allowing some thermal and gas exchange between the sheltered biosphere and the host surroundings need be designed.

A successful demonstration of communal living on Titan would be an envelope-pushing feat well beyond the most daring past precedent. In comparison, survival on the Moon or Mars will be seen to have been as easy as survival in Eden.

Building such a xity would be quite a challenge. We now know little about the surface of Titan and our guesses are constrained by insufficient data. We've narrowed down our estimates of the surface temperature range which will be the governing factor. Probably we have a surface that is some combination of extremely cold diamond hard water-ice and rock outcroppings or nunatuks (exposed mountain peaks in a glacial sea). "Near" the "triple point" of methane (where the gas can coexist with its solid and its liquid), there are possibly fields of methane snow, slush, and ice or lakes of liquid methane salted with an anti-freeze of other hydrocarbons rained out of the atmosphere. The European built Huygens probe which will ride piggyback out to Titan aboard Cassini, will hopefully tell us much more - though sadly not equipped to take pictures.

Some things are already clear. A xity on Titan would be a relatively hot thermal pocket in a deeply permafrozen world, a combination that spells trouble. Building it directly on, let alone into, the surface would spell disaster. The xity's heat would melt the surface underneath. The entire installation would slowly melt its way into the subsurface, sinking until its heat generating capacity stopped or was overcome.

Instead, Xenopolis must be a thermal preserve, a heat island insulated from the surface. Perhaps a "wind-lined" megastructure built on some sort of non-thermally conductive stilt-work footing near surface winds circulate freely underneath, carrying heat leakage away into the atmosphere's thermal sink.

The amount of human activity Titan could bear without upsetting the prevailing thermal equilibrium of the environment may be limited. Almost certainly, however, there is enough leeway in that equilibrium to tolerate a few isolated settlements and auxiliary outposts. We should be able to speculate more accurately after Cassini-Huygens.

Xenopolis must be designed to be heavily insulated from the surrounding cold, for the mutual protection of both exterior environment and interior ecospace. The heat generating activities within, basic life and agriculture activities and the mix of commercial and industrial activities, must be

carefully planned with the thermal budget in mind. So first the xity-hull or shell must be designed and its "R" value pinned down with accuracy. Next the thermal budget equation must be worked out, desired industrial activities balanced against the remaining leeway in the equation. Probably practical efficiency will dictate a certain overall size and population capacity. In general, as with animals (compare the mouse and the whale) the larger the overall structure, the smaller the volume to surface ratio, the easier to retain needed heat.

Erecting such a xity in such adverse conditions will be a challenge beyond ready comparison. Would it best be built in the upper atmosphere, suspended by lift balloons or dirigibles, then when completed lowered to the surface? We invite your further speculation. Meanwhile here are some trial balloon sketches to whet your imagination.

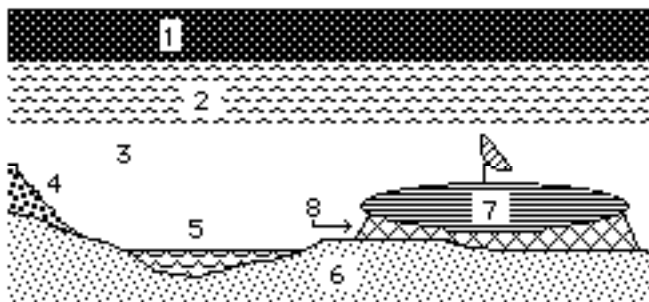

XITY ON TITAN - XENOPOLIS: 1) Space and Vacuum above N2 atmosphere; 2) unbroken cloud cover and strata; 3) possible transparent area of atmosphere near surface; 4) mountain; 5) liquid hydrocarbon lake or sea of ethane?; 6) surface of unknown proportions of rock and ices (water ice, ammonia ice, etc.); 7) hull of xity, saucer shaped to deflect winds and dissipate heat; 8) open trusswork of stilt supports to allow winds to circulate beneath xity and keep frozen terrain insulated from xity heat.

For scale of trial outpost settlement and one suggestion of interior arrangement, see below.



Settlement "arcology" of size indicated for 3,000 people.

To act as a thermal barrier and further lessen heat conduction to the surface, one entire level of supportwork joints are physically separated.

The main settlement mass and thermal island is magnetically levitated above the lower stilts. See below.

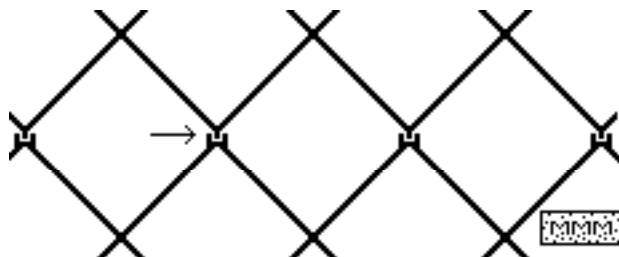

Keeping **WARM**

SURVIVAL Beyond the BELT

by Peter Kokh



AMOUNT OF LIGHT AND HEAT RECEIVED FROM SUN AT: E Earth, M Mars, J Jupiter, S Saturn, U Uranus, N Neptune. "Insolation" decreases as the square of distance from the Sun. Solar Power Systems become ineffective much beyond Mars.

COMMUNICATIONS TIME-LAG

ROUND TRIP RADIO TIMES: Earth to/from outposts at

The MOON	2.5 secs
MARS, Phobos, Deimos	6 - 44 min
JUPITER, Callisto, Himalia	1.1 - 1.8 hrs
SATURN, Titan, Iapetus	2.2 - 3.1 hrs
URANUS, Miranda, Oberon	4.8 - 5.8 hrs
NEPTUNE, Triton	8.0 - 8.7 hrs

The Moon orbits at a "teleoperable distance" from Earth. "Conversation" between Earth and Mars would be strained even at opposition when the two are closest. Beyond that, communication might as well be via the Post Office.

The Challenges to Settlement in the Outer System

There is more to survival out beyond the asteroids than finding and tapping a complete technology-supporting range of resources. Thermal budgets - keeping warm, and powered - will be primary concerns. Options available in the Inner System, specifically Solar Power, will not apply out here. Architects, builders, and engineers will face new challenges in balancing thermal inputs and outputs, in the creation of Oases not only of life in barren sterilizing surroundings, but of warmth in the midst of heat-sucking cold.

Communications with the inner human worlds and outposts will lack immediacy. Time delays by radio range up to several hours, making casual exchange impossible, carefully planned and prepared transfer of information the rule.

But if these irremediable difficulties are not enough to discourage, the difficulties of actual travel between Outer System outposts and the Inner System worlds of Earth, Moon, Mars and sunshine-basking space settlements - and indeed between the far scattered Outer System cities themselves - will be enormous. With chemical rockets any such journeys must take years, entailing mortal risk of accumulative exposure to cosmic radiation and solar flares, and spirit-snuffing boredom.

Clearly, we will not essay in the flesh into the Outer System, much less establish permanent presences there, until we've developed and perfected much speedier modes of travel. Even with nuclear rockets, no one will venture out-system without accepting that in medical, biospheric, or mechanical emergency they will be left to their own resourcefulness. Resupplies will need to be scheduled proactively anticipating likely emergencies, not reactively in response to actual ones.

The process of shedding umbilical support lines from the Mother World will have begun with Lunar Settlement. But Lunans will yet have access to props, relief, and rescue that will be out of the question for Martian trailblazers. These New Worlders will need to be much more self-reliant, much more accepting of risk without backups. Slowly, as the range of the human species expands at first beyond the cradle world to its moon, then beyond the Earth-Moon system to Mars and the near asteroids, the links of communication, commerce, and travel will become skimpier and skimpier, yet always remain enough to maintain a sense of joint community, of family.

The Oort Cloud, the Heliopause & Beyond

There is a long list of scientific unknowns about the Oort Cloud, a conjectured spherical halo of distant comets that may accompany the Sun in its galactic wanderings. What is the characteristic chemical makeup, mass and size range of this comet population? How pristinely undisturbed is that makeup? Do these comets, innocent of visits to the warmth closer in to the Sun, show tell-tale traces of close encounters with other passing stars? Is there a Rosetta stone to unlock the history of such encounters? How densely populated is the cloud?

Space dreamers need to know if the Oort Cloud holds significant *practical* implications for human expansion into the Solar fringe and beyond. Cometary ice can serve as impact bumper shielding for hypervelocity craft, or as fuel caches, but will the ΔV penalties of shedding expensively bought momentum in order to rendezvous and load be worth the effort? Do such comets contain any reserves that are not more easily tapped in sufficient abundance within the more easily accessible Outer Solar System? Do they contain enough of everything we would need to establish a scientific outpost on one of the larger of the host? At this point we can only wonder.

Between "the Cloud" and the nearest true stars, are there as yet unsuspected systems, planet and moon bearing rogue Brown Dwarfs? Such "infrars" are massive enough to glow with the warmth of slow gravitational contraction but not massive enough to experience or sustain nuclear ignition and burning, the source of true starlight. We can statistically expect to find a dozen or more such dud stars and systems neighboring us more closely than Alpha/Proxima Centauri. Would experience gained learning to survive and thrive in the frigid Outer Solar System, e.g. on ice-firmamented oceanic Io and on exotic Titan prepare us, even give us enthusiasm for settling such "Brown Systems" as destinations in their own right? For surely they will serve no purpose as stopovers! Settlement of such systems would have to stand alone, not be dependent on the crutch of import-export trade or sold on the basis of benefits to the parent circumsolar economy.

For our inevitable toe-wetting extra-solar excursions out beyond the haunts of Neptune & Triton, Pluto & Charon, Helium-3 Fusion Arks would, at this juncture, seem to make the best bet. Engineering wise, "Matter-Antimatter Drives" are still very much in the realm of Science Fiction no matter how theoretically legitimate. Compared to other nuclear fission and fusion choices, clean He3/D will require significantly less massive shielding and superstructure distance between engine drive units and the crew quarters of the "ark". That will dramatically lower the threshold, hasten the first breakout foray. **TRMM**

MAILBOX

NASA's Explanation of Why it Throws Away the Shuttle External Tank in each and every Mission:

[Ernie Bergman, a long time MMM subscriber and supporter, and a co-founder of the Greater Detroit Space Society, wrote U.S. Senator John Seymour (MI) to complain of NASA policy and Congressional indifference with the respect to the continued "wasting" of a potentially significant "bootstrap" resource, namely the Shuttle ET. Ernie mentioned that there were already a number of well-thought out plans to use the ET. Seymour passed on this letter to NASA and the letter printed below outlines NASA's reasoning. Thanks, Ernie!]

Thank you for your May 9, 1992 letter on behalf of Mr. Ernest Bergman who suggested that NASA use expended, retrofitted Space Shuttle External Tanks (ETs) as a Space Station.

NASA has no plans to adapt expended ETs for use in the Space Station Freedom program. In the early planning phases of the program, NASA considered the use of ETs as potential building blocks for a Space Station. Based on a thorough assessment, the idea was rejected for several reasons. For example,

[✓] the very large size of the ET exceeds NASA's resource capability to outfit it with the equipment necessary for electric power, life support, stabilization, and instrumentation. Further,

[✓] due to limited ground-to-orbit lift capability, the ET would have to be outfitted on orbit. In addition,

[✓] it would be technically difficult to purge the volatile material from the tank and modify the internal structure so that it could be effectively used.

[✓] Maintaining the tank's stability during this activity would be very difficult to accomplish.

The current restructured Space Station Freedom design using a truss and modular design approach offers

[✓] a flexibility that would not be possible with a Space Station constructed from ETs. Our design will allow for additional modules to be incorporated into the structure as future needs and resources dictate.

Martin P. Kress

Assistant [NASA] Administrator
for Legislative Affairs

[EDITOR'S COMMENT: Senator Seymour accepted NASA's response without question and this helps illustrate what we are up against politically. Fortunately, commercial endeavors need not be bound by such defeatism and sheepish resignation.

Where there's a will, there *may or may not* be a way. It's certain, though, that *when* there's *no* will, there *is* no way. NASA is poorly motivated to use the ET resource and thus it should not be surprising that the Agency has gone through only

the first half of the brainstorming process. It has ferreted out all the reasons why something won't work. Full stop. But then you're supposed to creatively brainstorm all the ways you are *going to* [stress on determination] "make it work anyway".

In fact, all of NASA's objections can be met - *or shown to be irrelevant*. Without going into the debate point by point, let's simply escape its terms by changing the rules. *If* it is in fact too difficult to retrofit a "wet" ET "in orbit", we can nonetheless alter the standard mission profile so as to save them in orbital "reservations", parking them in a high enough warehousing orbit until the day we do have the capacity to remodel them, or mine them for their aluminum and copper.

Meanwhile, **it IS possible to build ET-hulled modules fully outfitted on the ground, and launch them ready to occupy** and connect to auxiliary trusses etc. In the most imaginative piece* of ET-Brainstorming we've seen to date, J. M. Snead, an SSI Senior Associate from Beavercreek, Ohio describes a "Shuttle-S", a "Shuttle-derived vehicle that carries a ground-modified ET into orbit *as the primary payload* [which] consists of a modified ET hydrogen tank, intertank, and a top payload fairing that takes the place of the oxygen tank. Following the Skylab example, the ET's hydrogen tank would be converted during production into the primary pressurized module for a large space station."

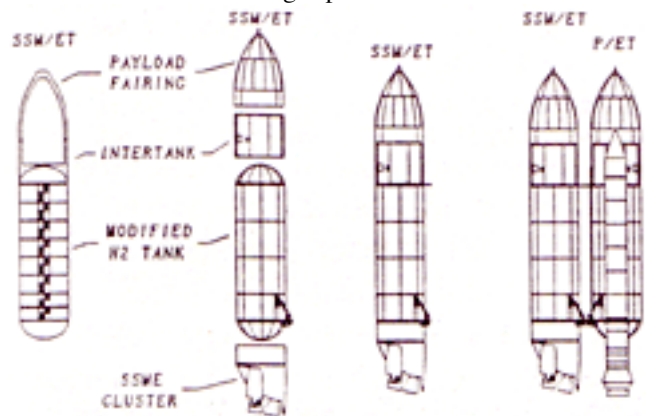

Figure 5 - Shuttle-S

This Space Station Module ET (SSM/ET) is mounted atop a cluster of Space Shuttle Main Engines (SSMEs) and attached to the regular unmodified fuel carrying ET in place of the orbiter. This yields an estimated allowable total payload for the outfitted modified ET station module of 175,000 lbs including the SSME/OMS/RCS/avionics cluster and OMS/RCS propellants. The advantages are these:

1. the basic components are off the shelf.
2. We would not be boosting unmodified ETs but rather "ET compatibles" fully outfitted habitat and lab modules using ET components for a hull - therefore ET assembly lines and ET fabrication facilities.
3. (The ET compatible modules would not have to go through a time-consuming and expensive "man-rating" hoop-set for launch since no crew would accompany it to orbit.
4. Much more gets launched in a single shot.
5. EVA time needed to ready the module for occupancy and use is held to a minimum - below that needed for Space Station Freedom.

Snead's specific design need not be followed but it clearly points the way. While *Freedom* may ultimately cost as much as \$10B per bed (4), a one module ET-compatible station might cost as little as \$100M per bed (12), 100 times less!

As Snead points out, NASA has chosen to start with a "clean sheet of paper" offering maximum flexibility and efficiency of design. The inescapable penalty is the need to design and develop all new components and the factories to build them, a process that guarantees delays and cost overruns that are not justified by the marginal extras to be gained.

Snead's philosophy borrows a page from the English inventor of radar, Robert Watson-Watt, who describes the "Law of the Third Best":

The "best" never comes. The "second best" takes too much time. Design a product that works - the "third best" - and build it. The third best design is the one which "can be validated without unacceptable cost or delay".

It all comes down to this. Sp. Sta. *Freedom* costs so much because NASA is building it to satisfy a *set* of priorities totally inappropriate to the opening of the space frontier.

But it also means that **the place to get into the ET station business is**, not Colorado or wherever, but at **Michaud, Louisiana next to the Martin Marietta plant** where newly built ET hulls can be accepted for custom outfitting before transit by barge through the intracoastal waterway to the Cape. In other words, the "real ET company" is an enterprise yet to be formed. **PK**

[* **SPACE BASE I:** Building a Large Space Station Using External Tank Technologies. A paper given at the 1991 Midwest Space Development Conf. in Dayton, Ohio by J. M. Snead, P.E., 4236 Straight Arrow Road, Beavercreek, OH 45430-1519.]

In this paper, Snead goes beyond the one ET module station to sketch a 170 person (!) 16 spoke rotating station with 21 ET compatible modules, all for about the price of *Freedom*! Alternately, four complexes a fourth the size, one each in LEO, GEO, lunar orbit, Mars orbit. His design has at least one definite flaw - much too tight a radius and therefore much too high an rpm rate to provide a *tolerable* artificial gravity. But it does illustrate the potential of ET compatibles.] **PK**

MMM #60 - NOV 1992

Creating "terra firma" where there is none.

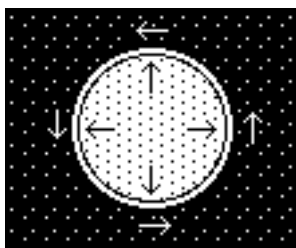

Three dimensional beings, our existence is utterly polarized by an up-down gravitational gradient structuring our lives along a resisting two-dimensional surface: terra firma, hard ground. In space, left, we can create effective terra firma from scratch by rotation. On

surfaceless or surface-hostile planets, right, we can create hard ground in high-floating atmospheric aerostat structures.

⇒ *below.*

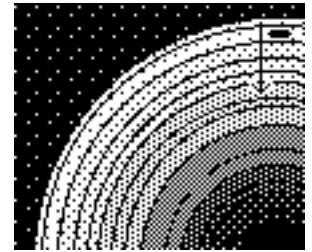

[Series Conclusion]



Pronounced KSIH-tees, not EX-ih-tees
[Human communities beyond Earth's cradling biosphere]

By Peter Kokh

***PUSHING THE ENVELOPE:*
Aerostat Xities "afloat"
in the atmospheres of
Venus, Jupiter, Saturn,
Titan, Uranus and Neptune**

We think of Venus and the outer "Gas Giant" planets as forbidding places forever "off limits" to humans. Each has a thick crushing atmosphere and either an unsurvivable surface or no real surface at all, abysses or abysmal lands were the temperatures and pressures far exceed all human capacity to adapt - even within techno-miraculous protective cocoons.

Yet there are thinner, higher, more temperate regions in the atmospheres of each of these hell planets where the conditions are *relatively* benign. Such planet-girdling pseudo "ecospheres" lack but one thing to make them attractive sites for human outposts or settlements - "terra firma", solid land *at the seemingly benign levels.*

But this lack is something we can, with determination, do something about. We only need to expand conservatively on the known concepts of lighter-than-air craft. Several people have been predicting the return of great dirigibles to Earth's own skies. Visionaries have gone further to speculate about aerostat outposts high in Earth's atmospheres - not transportation vehicles but lighter-than-air "platforms", either free-floating or tethered to a surface location. These could serve various purposes: remote sensing, air traffic control, military command posts, and rocket launching space ports above the thickest layers of the atmosphere.

In the oxygen-rich atmosphere of Earth we would need to use helium gas for buoyancy. But in the atmospheres of the gas giant planets, a helium balloon would sink! These atmospheres are largely hydrogen with smaller portions of heavier gasses: helium, ammonia, methane, and lesser contributors. There we would have to separate the gasses and use just pure hydrogen which would weigh less, volume for volume at given pressure, than an equal amount of mixed gas-giant "air". As the advantage in buoyancy in this case, about **1.15:1** will be nowhere near as favorable as the 7-fold+ lifting

power of helium in terrestrial air, the ratio of buoyancy container volume to gas envelope mass and platform mass supported would have to be quite large for aerostat facilities on Jupiter and its kindred planets.

Yet gas giant aerostats remain *barely* doable using the lightweight composite materials and fabrics now available or in the works, many of which could be fabricated *in situ* by mining the atmosphere itself. Available in gas giant atmospheres, as well as in Titan's, are hydrogen, carbon, nitrogen, oxygen, sulfur, phosphorous, and germanium and other elements present as methane, ammonia, ethane, propane, phosphine, hydrogen sulfide, carbon monoxide, acetylene, water vapor, germanium tetrahydride, and other compounds.

In the case of any of these planets, the feasibility can be tested by dropping into the upper atmosphere a pressurized crew compartment carrying an inflatable gas envelope, the lift gas with which to inflate it, and an underslung *Pegasus*-like shuttle by which the crew could escape to orbit.

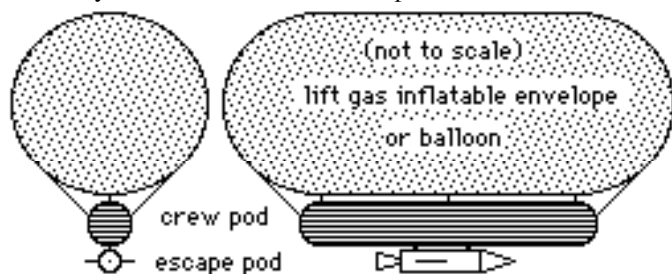

Such a demonstrator aerostat could help define the ideal float altitude, stabilization mechanisms, and thermal management strategies. The crew could experiment with pilot atmosphere mining and processing equipment, with options for deriving energy from the atmosphere, and identifying problems. Surface observations (Venus, Titan) and atmospheric science would be done on a contingency basis.

Why Aero-Xities on/in the Gas Giant Planets?

If large enough xity-sized aerostats could indeed be built, in whole or part, with atmosphere mined and processed materials, they could serve for extended meteorological research *and biospheric experiments* within the pseudo ecosphere levels of the host atmospheres. If indeed they do not already exist, could we bioengineer bacteria and eventually higher unicellular and multicellular plant and animal varieties - even whole ecologies - to survive in atmospheric sargasso oases on these planets? Several Science Fiction writers, Arthur C. Clarke among them, have already speculated along such lines.

If eventually successful, such research would teach us much about the adaptability of life, and better prepare us for the greater universe of possibilities beyond our home System. As little as we can as yet safely say about planetary systems in general, having examined but one example, there can be no doubt that gas giant planets must vastly outnumber terrestrial or terraformable ones.

We must see our role not only as spreaders of our own species, but of life period. There *must* be places where life cannot arise on its own, but *could survive, once introduced*. Only intelligent species can serve as the means of such propagation. Gas giant planets may provide us the vast

majority of our opportunities, even if they do not (now seem to) make ideal settlement hosts for significant numbers of our own kind. Our mission, not to rape virgin worlds but to turn them into new motherworlds dates not from 1957 (Sputnik), nor 1902 (Tsiolkovsky), nor 1867 (Verne), but back billions of years at the dawn of life itself. Humanity and technology are come together as the reproductive organs of Earth-life: *Gaia*.

On the Oceans of Uranus and Neptune?

Voyager II revealed Uranus to have a molten rocky core 13,000 km (8,100 mi or about the size of Earth) in diameter with an ocean of water 8,000 km (5,000 mi) thick. That's a volume of water almost eleven times as vast as the entire volume (rock *and* water) of the Earth and more than 40,000 times as great as the volume of Earth's ocean alone which, if our continents could be plowed into the ocean basins to create a uniform solid surface, would lie 2.7 km or 1.7 mi thick. But Uranus' ocean, a brine of water, liquid methane, and ammonia, must be super-heated to a thousand degrees or more, prevented from boiling by the crushing burden of the atmosphere above which is 11,000 km or 6800 mi thick. Neptune's inner structure must be similar. So while these planets are not totally gaseous as once thought, and do have "surfaces", reaching them even with robotic instruments will be enormously more difficult than reaching the surface of Venus. Aerostat xities, if any are ever built, would be limited to float levels very high up in those thick Hydrogen-Helium atmospheres.

The all but absent signs of lightning and whistler waves on either planet indicates relatively little updraft and thus probably not much in the way of 'rain' or 'snow'.

Neptune has 3000 times as much high atmosphere methane (thus much greater supply of carbon at aerostat float altitudes) as Uranus' meager 10 ppm.

Titan and Venus







The outlook is actually much better for aerostat xities in Titan's rich dense atmosphere, where the full available lift of hydrogen is available in the much heavier nitrogen milieu, as can be seen in the chart below. A Titanic aero-xity might be the way to go if Titan's surface proves too treacherous or too challenging to host a settlement directly.

The lift numbers are also good in the case of Venus. The Veneran atmosphere, mostly carbon dioxide CO₂, has an even higher average molecular weight, 44, than does our own atmosphere, 29. Further, since carbon dioxide suffocates rather than feeds combustion, it would be quite safe to use hydrogen (molecular weight 2) for buoyancy. The 22-fold lift advantage would mean a given dirigible volume structure in Venus atmosphere could support 3 times as much platform mass as a similar structure in Earth's atmosphere where the helium to air lift factor is 7.24.

Hydrogen, in the form of water vapor, is present in Venus' atmosphere but in nowhere near the same abundance as on Earth. We'd have to process an enormous amount of Air de Venus to get enough for our needs. Helium is unavailable on Venus so ammonia (NH₃, molecular weight 17) and methane (CH₄, molecular weight 16) are the next lightest gases that could be processed on site. But since they both incorporate hydrogen, the same strictures apply.

There *are* alternatives. We could either separate out nitrogen, N₂, molecular weight 28, or process the CO₂ to produce equal amounts of carbon monoxide, molecular weight 26, and oxygen, molecular weight 32. We'd save the oxygen for the internal breathing atmosphere of our aerostat xity, and

use the CO for buoyancy, making do with a 1.7:1 lifting ratio for a mere 1/13th the payload or supported platform mass. That is, for an aerostat xity of given design size and mass, our gas bags would have to have 13 times the volume (2.36 x both radius and length) if they are to be filled with CO rather than H₂. While discouraging, the prospect of having no lighter buoyancy gas than carbon monoxide would not rule out aerostats for Venus, just raise the engineering threshold. Even with CO, Veneran aerostats, size for size, could support half again as much platform mass as their Jovian equivalents.

Earth H ₂	Earth He	Titan H ₂	Jupiter H ₂	Venus H ₂	Venus CO
14.5	7.25	14	1.15	22	1.7
					

RELATIVE LIFT OF AEROSTATS FOR VARIOUS PLANETS. (Relative Mass of Platform Supportable per buoyant volume) The 2nd column shows the standard situation and practice on Earth where Helium is now used instead of Hydrogen for safety reasons. By comparison, an otherwise similar hydrogen aero-stat on Venus could lift 3 times the platform mass. But CO lift at Venus and Hydrogen lift at Jupiter are quite handicapped.

Of course, aboard an aerostat, one would experience weight just as one does aboard an airliner. That weight would be the same as one would feel standing on a mountain at the same height. For aerostat xities, there will be no need for artificial gravity. The environment will supply plenty.

GRAVITY AND WEIGHT IN AEROSTAT XITIES

Earth	1.00 G	150 lbs
Venus	0.90	135
Jupiter	2.64	396*
Saturn	1.16	174
Titan	0.15	22
Uranus	1.17	176
Neptune	1.20	180

* Obviously, a Jovian aero-xity would attract few volunteers.

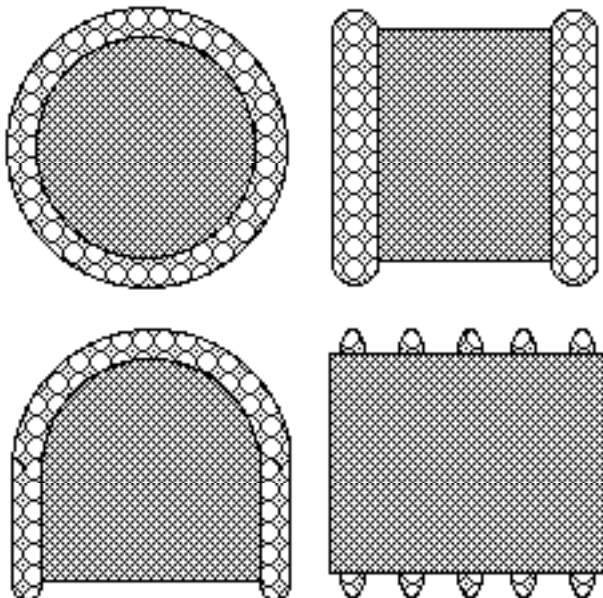

OPTIONAL AEROSTAT PLANS (Overhead): A gas filled hull providing buoyancy support of the central platform on which habitats etc. sit, or from which they are suspended, could be in the form of a torus (top left), catamaran (top right), horseshoe (bottom left), pontoon raft (bottom right)

POWER AND THERMAL MANAGEMENT

How would an aero-xity get energy with which to go about its business? Solar Power is not an option anywhere in the Outer Solar System, or beneath the cloud decks of Venus. Helium-3 and Deuterium are available in the atmospheres of the gas giants for use as fusion fuel. The availability of Helium-3 in Titan's atmosphere is uncertain, however.

Energy production on Venus will have to be more resourceful. Could lightning be harnessed? What about some analog of OTEC, circulating a working refrigerant liquid between hot lower atmospheric levels and cooler upper ones? As to thermal management, that should be a simple matter of picking a float altitude with the right temperature.

THE STRUCTURE: Since the chosen flotation level is thermally and barometrically neutral, the 'tight' hulls of habitat structures supported on the central platform are needed less to insulate and pressurize than to contain breathable air in a setting of unbreathable ambient atmosphere. Bladders in the torus or catamaran "pontoons" can moderate buoyancy if it becomes desirable to float at some higher or lower altitude.

"Valentine Heights": Aero-Xity "on" Venus

While there may be valid reasons one would want to someday build aero-xities in the gas giant planet atmospheres, especially at Uranus where the economic opportunities are greatest and the gravity well penalties most manageable, [see last month's articles in the Xities series.] it is clear that the most negotiable venues for such floating outposts are Titan and Venus. Let's expand somewhat on the latter possibility.

First we'll attempt to satisfy your growing visual curiosity with some MacPaint 'artistic' renderings to suggest what such constructs might look like. Then we'll discuss why on Earth (or Venus!) we might someday want to deploy them.

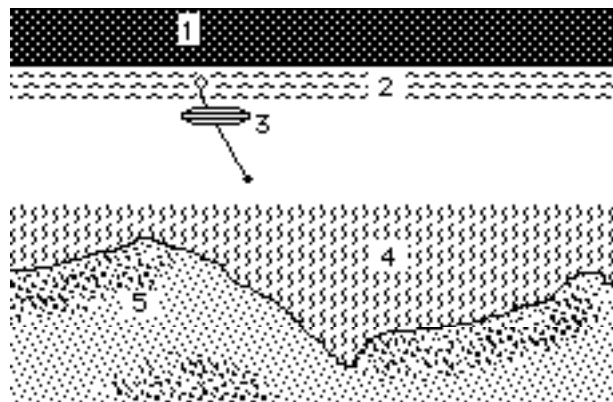

FLOAT LEVEL OF VENUS AEROSTAT XITY: 1) Space and vacuum above the atmosphere; 2) Unbroken cloud level 30=40 miles above the surface; 3) Venus aerostat xity floating just under the cloud deck about 30 miles (150,000 ft.) above the surface in cool CO₂ atmosphere at the 1 ATM pressure level with a clear view of the surface. An upper atmosphere meteorology station is borne on tethered

balloon above while a lower atmosphere station is trailed by tether below; 4) the super oven-hot super dense lower layers of the atmosphere; 5) Super hot surface of Venus: continents, empty oceanic basin, craters, volcanoes live and dormant, mountain massifs, valleys and trenches.

While on the surface dusky daylight and lightning-punctuated darkness cycle every 118 days, aboard the aero-xity riding 300 kph winds, dawn comes every four days.

“Valentine Heights”

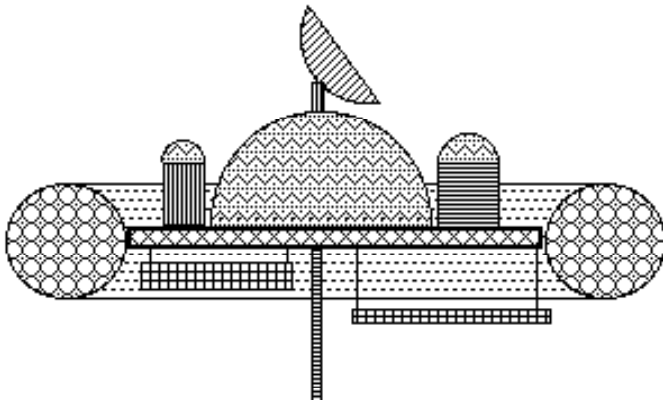

KETCH OF VENERAN AEROSTAT XITY: Cutaway of a large donut torus or horseshoe float with cellular ballonets and bladders provides buoyancy support for the xity. Hydrogen gas is preferred, but carbon monoxide processed more easily from the atmosphere will do. The torus directly supports the central main spaceframe platform. Standing on the platform are a central residential-agricultural-environmental dome and auxiliary domed vertical cylinder structures. Below is suspended an elevator to a lower meteorology station and two open-air platforms: the one on the left supports teleoperated refining, processing, and manufacturing from atmosphere-sourced chemical feedstocks; the one on the right is a landing & take-off platform for unpiloted drone aircraft for close near-surface observation and teleoperated surface sampling and mining.

“Cupid’s Blind”

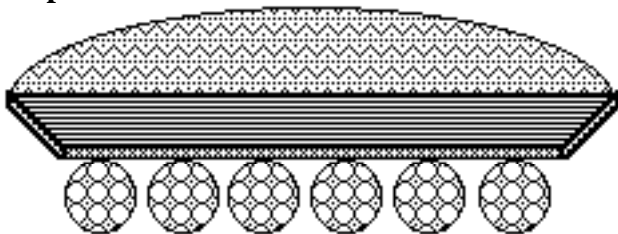

This advanced scheme would employ a larger pontoon-raft for support. The “open air” environment would feature terraced interior side slopes under an overall skyblue dome.

BUILDING IT: While structurally, there is no reason why such xities could not work, actually building one is quite another problem. Would it be built in space and then lowered with “sufficient gentility” into the atmosphere? Would you instead bring in only a starter structure i.e. a buoyant processing plant, then begin to mine the atmosphere for feedstocks from which to make building materials (e.g. carbon into Kevlar and structural graphite?) out of which to fashion the great

remaining bulk of the structure? The atmosphere of Venus offers much less diversity of elements with which to work chemical magic than do the atmospheres of the four gas giant planets or Titan. The architectural, engineering, and construction challenges either way are rather daunting. So the sketches and concepts above may prove to be as unrealizable as much of the great “glimpse of the future” cover sketches of issues of Popular Science and Popular Mechanics of half a century ago. Anyway, we have tried to stimulate your imagination.

INDUSTRY: If all that Veneran “cloud miners” have to work with are C, O, N, H, and S - carbon, oxygen, nitrogen, hydrogen, and sulfur, then in addition to agricultural products (importing phosphorus and other micro-nutrients) what serviceable synthetic materials could they produce? And what sorts of things could they make from them? Structural elements from which to expand? Mere low-performance furnishings and craft stuffs? Are exotic nitrogen-based ceramics and Kevlar among the possibilities?

The fewer basic needs can be met by self-manufacture from ambient elements, the more must at first be imported at high cost. Eventually raw materials for manufacturing might be supplemented by ores “tele-dredged” from the torrid surface.

MISSION?: What purposes might a Veneran aero-xity serve? Well, for one sure thing, such a supremely isolated and self-quarantined place might make the ultimate ‘Alcatraz’. You wouldn’t even need guards. Supplies and fresh inmates could be brought in by tele-piloted craft with no manual overrides. Anyone want out? Just step out the airlock and take a breath of Veneran air, or walk the plank off the main platform and plummet into the incinerating sulfurous hell depths below. Hey, Halloween *is* coming up!

On a less ghoulish note, such a facility would offer unequaled opportunities to conduct Venus science and exploration: An economic geography of the planet could be pieced together against a far future day when we might somehow be able to transform the pressure-cooker atmosphere into something humans can handle, with unproxied access to the surface.

A down-facing observatory would map the Veneran terrain below using multi-spectral remote sensing techniques. More ambitiously, rugged oven-hardened ceramic-hulled, diamond-wired teleoperated explorers, samplers, and eventually miner vehicles, etc. might be developed to serve as our stand ins on the surface, operated by crews in the aero-xity. These could be stationary surface stations or mobile ones. Prior to this, we could begin to get our feet “hot”, probing every lower and lower as the hardness of our equipment allows, by drone airborne craft teleoperated from “The Heights”.

Philosophically, the ultimate rationale behind an aerostat settlement over Venus may simply be our drive to continue brazenly pushing the “human envelope”. Born “naked apes”, we seem to have a deep-seated characteristic need to keep learning to first survive and then thrive in one seemingly more hostile environment after another. On Earth we’ve already long left our native tropical home lands and mastered the deserts and swamps, the temperate forests and grasslands, and even the arctic tundra and ice. The ocean deeps too have seen our first timid encampments. All of this courtesy of

technology, be it so humble as clothing, hunting and fishing tools, shelter building skills, and thermal management tricks of the trade.

Those who deem unnatural human expansion into the for-a-little-while-yet hostile reaches of space, only show that they do not understand our own history. Had they been in control, we'd still be in the cave or swinging from the vines or timidly darting across the savannas. Our species has no limit on where we might live and pursue our needs except those it sets for itself. And those who would confine our beachheads in space to the inner hulls of artificially gravid zoo-like imitations of old Earth, are hardly more daring than the stay-at-homes. There will always be some of us, however few, that will want to get away from the common haunts of our kind and test new niches, vault new hurdles, face new challenges. *Homo est animal incognitum probans*. We will build a xity over Venus because Venus is there.

Easier said than done, to be sure. To transform such a vision into reality, we will have to find ways to make economic sense of it all. But before even considering what such a community might trade with the human universe beyond the all-hiding cloud deck, we'll have to demonstrate ways to push local self-sufficiency to the limits with the very limited material feedstocks available locally - and for a long time that will mean "mining" the atmosphere alone, period!

Surely one of the activities furthered by such a cloud-hugging settlement would be brainstorming of the possibilities, challenges and strategies for "terraforming" this runaway greenhouse world. Most of what has been written to date, even by well known authors, fits the category of garbage in, garbage out. They all conveniently neglect one or more harsh realities which constrain the possible avenues of approach. We've been keeping a "Friday File" [Venus = Norse Fria] on the subject for a future speculative article. **TRAP!**

The proper adjective for Venus?

Alert readers will have noticed that NASA/JPL-folk use the term **Cytherean** as an adjective, e.g. the "Cytherean atmosphere" or surface or whatever. Why? Because the adjectives for names originating in Latin, like Mars, Jupiter, and Venus, are customarily built on the genitive (possessive case form) stem of the word. Thus we have Martian from Martis, Jovian from Jovis. But apparently these prudes, or if prudes they're not then these people scared silly of a Bible-toting public, are afraid to use the genitive of Venus. You see it happens to be Veneris, from which, oh yes, our word **Venerial**, as in disease.

Now Science Fiction Writers, equally skittish about seeming propriety, have gotten around the problem by using the nominative stem: Venus, **Venusian**. That seems harmless enough but the linguistic scholars howled foul. Hence the public servants in charge of space science have avoided the matter by using a totally different word from some beat-around-the-bush association. Cytherea was an island near the mythological ocean birthplace of Aphrodite, the Greek love goddess identified with the Venus of the Romans.

For our money, the Russians seem to have come up with the best solution. Use the genitive root, but add simply **-an** rather than the 'offensively suggestive' -eal, -ean, or -ian. Thus simply "**Veneran**". The reason it works is because the stress now falls on the *first* syllable instead of the second. A simple and elegant

solution! If any one out there is still so uptight about his/her own sexuality as to be still squeamish about that, so be it. The use of Cytherean is absurdly pathetic. So we've adopted the Russian use which is both linguistically defensible and free enough of other associations. **TRAP!**

[XITIES Series CONCLUSION]

Xities Beyond the Cradle: Unaddressed Challenges

by Peter Kokh

Pushing the Envelope

To many people, space enthusiasts are a strange lot. Sure, we all see plenty of room for improvement in living conditions here on Earth, but Earth is our only uninterrupted prehistoric and historic home. It seems unnatural or escapist to daydream and dally about new home settings beyond the natural integral, seemingly holistic surface of Earth. Earth *is* the "world" and everything beyond is but lights in the sky.

"World" can be defined philosophically as an integral or integrated complex of horizons, each leading into the other. The forest leads into the savanna, the savanna into the desert, the desert to the coast, the coast to the sea, the sea to other shores - embracing at last the entire surface of our home world. But the actual sense of "world" has already gone through a series of explosive expansions *and logistical integrations*. Our "civilization" (from Latin *civitas*, the city) is fast becoming a "Planetization".

In the course of this history, various exploring and expanding civilizations have renewed themselves and escaped stagnation of spirit, both collective and individual, by pushing their individual envelopes. Nothing could be more natural than for us to continue this process beyond "the Sky Barrier".

Dreamers have long imagined beachhead settlements on the surface of other celestial bodies: the Moon, Mars, the great moons of Jupiter and Saturn, even (naively) on Venus. Gerard O'Neill, and Dandridge Cole and John Bernal before him, exploded the timid limits of our vision to include space settlements organized around gravity-mimicking centrifugal force on the inside surfaces of rotating hollow spheres, cylinders and toruses. A few have talked about atmospheric settlements. The common thread has been that these locales are all beyond the clench of our atmospheric benefactor-jailer.

This is not to say that the current envelope of our planetization cannot be expanded right here at home. Seafloor settlements have stirred the imagination of many from the days of Plato's tale of mythical Atlantis and of Jules Verne's novel "20,000 Leagues Under the Sea", to ex-Mercury astronaut Scott Carpenter, and to the current League of New Worlds efforts (Challenger Station and Atlantis) in Florida.

Many space activists show marked impatience with this avenue of expansion. Witness the recent exchange of opinions in *Ad Astra*. Yet seafloor outposts provide a handy analog of space and planetary settlements. Many of the umbilical cord-cutting technologies and tricks we need to master can be developed and debugged in submarine settings -

indeed it is hard to imagine a better and cheaper and safer place to perfect our know how in pressurization, closed loop life support methods, and general self-reliance. Thus this disdain or annoyance is a sad testimony to the superficiality and self-defeating impatience of many space enthusiasts. *We'll succeed in space only if we have taken due time to do our homework.* We desperately need to embrace this opportunity.

Yet pushing the envelope of the human range is not just a matter of technological gee-whizzery. We propose to go not only “where no man has gone before”, but “where life itself has not gone before”. We would not only leave our cities but the encradling global biosphere Gaia *whom* we can take for granted no more. The biospheric challenges are even greater than the engineering ones. Yet somehow most enthusiasts seem to think all this will just somehow fall into place once we have cheap access to space. The techno-fixation of *all* pro-space advocacy groups (NSS leadership and membership alike decidedly included) shows that down deep, most of us are not really emotionally ready to be weaned from the Gaian teat.

Yet our rallying cry is “Ad Astra!”, “To the Stars!” Indeed given that the Sun and planets are formed from the ashes of generations of long dead stars, such a presumptuous journey would truly be an epic pilgrimage *home*. Such a journey, like all others, starts with a first step. We have to be patient with our baby steps if we are to make it all this way.

We need to tackle the many unaddressed challenges of our determined migration off-planet. Here are some.

Xity Construction and Maintenance

Off-planet settlements or xities must first of all do an effective job of containing a breathable atmosphere. We know how to make small pressure hulls, somewhat. The Shuttle, for example, leaks at a rate that would create an unacceptable air-replacement burden at the distance of the Moon or beyond. We need to do better. And as we move from simple structures to complex ones integrating a number of modules and pressurized connectors in a uni-atmospheric maze, the criticalness of adequate joints, seals, and vibration-hardiness will grow acute.

Space Station Freedom could have been a learning experience in this regard but we have chosen (is it really a choice when nothing else is even considered?) to use seals and sealants that can be manufactured only on Earth rather than develop and test those that could be duplicated in early settlement technology reliant on locally available raw materials. NASA's charter R&D mission is unthinkingly mistargeted, given our stated goals. Thus early outposts on the Moon will succeed merely in giving us a totally unearned sense of achievement, setting us up for eventual and certain failure.

The growth or expandability of surface and space settlements is an important topic we've taken up in previous articles. It is a challenge for engineering, for biospherics, and for economic and cultural health. We have few good answers.

Initial Challenges For Biospherics

The obvious purpose of extra-terrestrial mini-biospheres is to provide sustainable and adequate fresh air and water and food for the inhabitants. Many would reduce this to an agricultural equation. What can we grow in a given climate to provide a varied and balanced diet? But we will also need other agricultural products: fiber, pharmaceuticals, household

preparations, cosmetics, and industrial-chemical agents and feedstocks for which it is not yet feasible to produce an inorganic substitute based on local raw materials.

Further all the plant and animal species and varieties we need for all these purposes must co-exist in some sort of feed-back balancing ecosystem. Further, even if we are eventually successful in meeting all these design goals, our mini-biosphere will likely be unequal to the task of keeping the air and water fresh. We need an unexpectedly and discouragingly large a biosphere in ratio to the size of pioneer population to be supported. That Biosphere II is having problems maintaining oxygen levels without CO₂ scrubbing is an important lesson and achievement of the experiment.

The health of the biospheric environment aside, our confident expectations that humans can adjust to significant fractional gravities like that of Mars (38%) and the Moon (16%) are yet to be validated. It is not only the physiological health of the original settlers that is in question, but that of their first and successive generation off-spring. Here, aside from the limited predictive value of experiments with artificial-g and generations of short-lived fruit flies aboard Freedom, there is little we can do but dismiss all hesitation in getting our feet wet. A bureaucratic ban on pregnancies on the Moon or Mars will be immediately and directly self-defeating.

Because of the possibility of eventual isolation and an interruption in immigration, initial genetic diversity should be prudently given priority attention.

The Aging of the Xity

We have barely begun to experiment with creation of mini-biospheres in the hopes of coming up with families of sustainable mini ecosystems. But ecosystems, like individuals, mature and age and either adapt or die. We haven't the foggiest idea how quickly or tolerably a mini-biosphere would age and its life-sustaining effectiveness degrade. With so much need for experiment, the temptation to criticize and dismiss the only ongoing experiment we have, Biosphere II, is criminal.

Vulnerability to microbial sports and accidentally imported unwelcome microbes and pests is a make or break area for research and brainstorming. The umbilical cord with Earth may be cut, but as long as there is trade and travel, settlement biospheres will be at risk for critical disruption.

Xity and World

Stagnation within the change resistant limits of fixed size settlement megastructures promises to be a real problem. Initial picture postcard beauty of settlement interior vistas may be achieved with deceptive ease - akin to what we now do in zoos. But over the long haul, the vitality of self-renewal and self-redefinition with the option for growth will be much harder to realize.

Clustering is one answer to xity stagnation. An effective “world”-plex of neighboring xities within which cluster travel is relatively easy, will do much to provide the relief of change of scenery, import and export of fresh ideas and methods and products. It is questionable if an isolated xity can remain socially and culturally sane. Surface networking of a plurality of xities on both the Moon and Mars are essential. But the same case must be made for effective clustering space settlements. Our off-planet communities will sink or swim by

their inclusion in workable new “worlds” made contiguous through trade and travel.

This networking will become strained as we move out to the Asteroid Belt and beyond into the Outer Solar System. Electronic networking will have to carry the load. But eventually sheer distance and associated time-lags will strain that accommodation also.

Logistic and Other Trade Challenges

Not only will xities need to band together to keep their civilizations healthy, they will need to do so for sheer economic survival. It is estimated (please don't ask me for a reference) that at today's level of material civilization, it takes a community of a quarter million (250,000) to support an economy diversified enough to supply 95% of its own material needs. It will be some time before we have individual off-planet communities of that size, let alone an aggregate of several settlements totaling that many souls. Even then, trade for that stubborn 5% of their self-unmet needs will be vital.

Earlier milestones of say 60% self-manufacturing *can* be met with far smaller populations. But then the need for existence-sustaining trade will be that much greater. This will put a priority on substitutions, making do, and doing without that would strain the gung-ho spirit of today's crop of Earth-spoiled would-be volunteers. Where export-import logistics are difficult, strained by high energy costs and/or infrequent launch windows due to shifting orbital alignments, imports must be planned ahead. Stocks of replacement parts must be maintained with religious care. There may have to be a brash acceptance of medical triage. The Moon is just seconds away by talk, a few days by walk. But replacing things on Mars and ordering things that have been inadvertently left out of original supply endowments will involve demoralizing delays. And beyond it gets worse. All the more need to set up a diversified multi-xity Martian (or asteroidal) economy without hesitant delay.

The Xity and the Stars

Science Fiction tradition is already rich in stories of inter-stellar arks containing whole ecologies and civilizations bound for prospective settlement locations around strange exotic suns light years away. This tradition was reinforced in the seventies with the development of the Space Colony concept. Space Colonies founded within the Solar System might presumably get bored with the challenge of life around our native star or become disenchanted with the prospect of continuing contact with the rest of Sun-huddled humanity, pick up anchor and sail for greener pastures and virgin sunlight.

In a very real sense, every off-planet xity will be an ark both for its human population and for its human-tolerant ensemble of plants and animals. The difference will be that the degree of required self-reliance will be “within reason”, that the degree of discontinuity with fellow circumsolar xities will be forgivingly less than absolute.

Yet these Sun-bound communities will serve to provide a preview of the “foresaker” spirit star-bound folk will need to display in uncompromised measure. Xities beyond Mars will demonstrate major reliance on electronic intercourse and carry self-reliant ingenuity to new heights of virtue.

We may never actually set out for the stars, and if we do, it may be by sending one-way seed and spore banks, not

communities of actual individuals. That is, humanity *and Gaia* may reach the stars by “propagation” rather than “travel.” If so, it will be because in pushing the envelope, xities have come up against limits to independence asymptotically impossible to attain or exceed. Xities will be nonetheless star-bound spores of the human spirit. As such they will be the ultimate manifestation of the root “star-drive” within us. MMMM

postscript to MMM # 60

Aerostat Xities:

Altitude, Pressure, Temperature Charts for Venus, Titan, Jupiter, and Saturn

By Peter Kokh

In October, I looked all over for altitude vs. pressure vs. temperature charts I knew I had seen for Venus, Jupiter, Saturn, and Titan. I finally found information with which to reconstruct such charts two days after #60 went to press. In none of these cases does the information suggest an ideal altitude. A choice will have to be made on the basis of tradeoffs and it is possible that on some of these planets no viable altitude will be found. Anyway, here is the situation:

[VENUS]

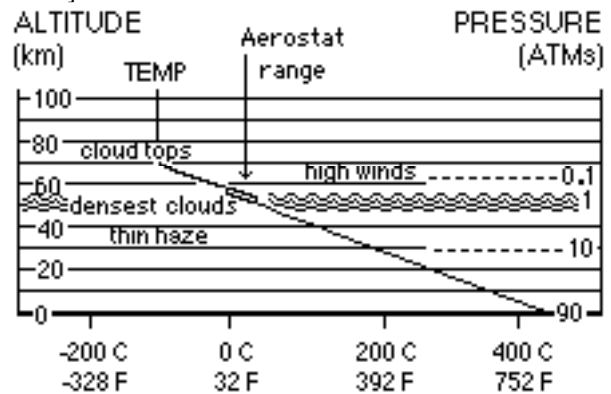

COMMENT: An aerostat should be overpressurized relative to the surrounding atmosphere - to keep out unbreathable gasses. At the 1.0 ATM level we are unfortunately in the middle of the clouds. And below the clouds where it is possible to monitor the surface the air gets thicker and hotter. A trailing tethered Surface Observer Station might be the answer. With no ideal compromise, safety, stability, thermal, and other practical concerns will be paramount.

[TITAN]

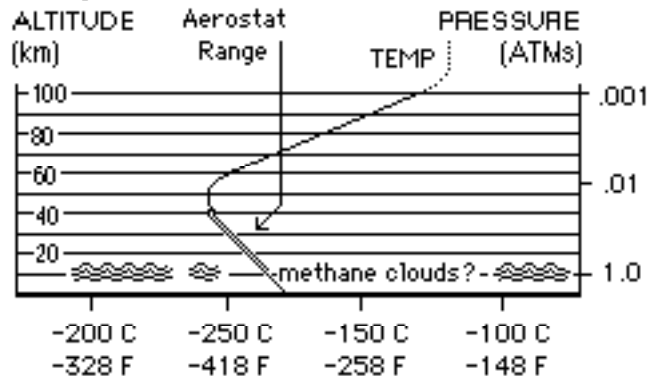

COMMENT: At all altitudes it is extremely cold on Titan. But above 70 some kilometers (230,000 ft) it is at least warmer than on the surface. But in the rarefied upper air that would be of little thermal benefit.

[JUPITER]

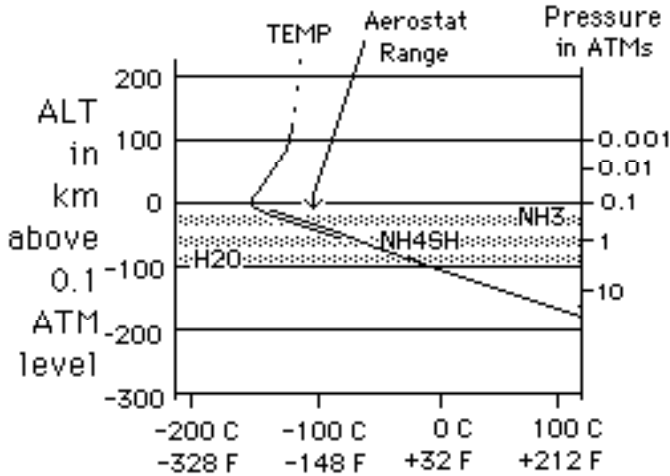

COMMENT: The altitude levels of the various prominent cloud layers is shown with their chemical composition. The "temperate" region of manageable pressures and temperatures runs through these levels.

[SATURN]

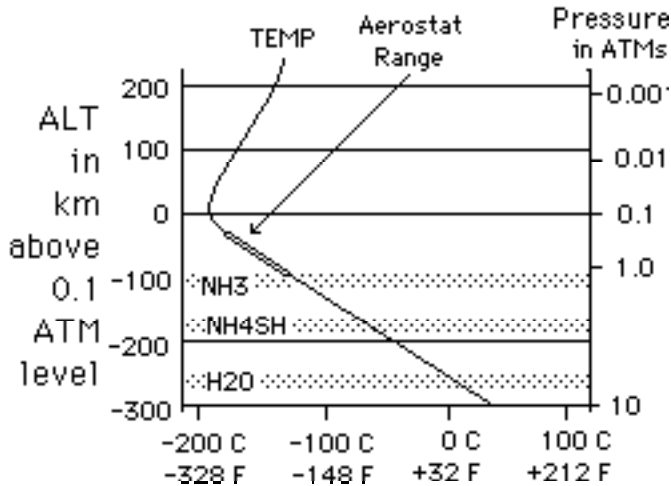

COMMENT: Again the level and chemical composition of three cloud layers is shown. It is somewhat colder at the desired pressure levels on Saturn than on Jupiter, but stationing aerostat outposts there should be workable **PK**

[The above **POSTSCRIPT** and the **MAIL** below are both from MMM #61, but I felt it essential to include it with this volume of MMM Classics. Ed.]

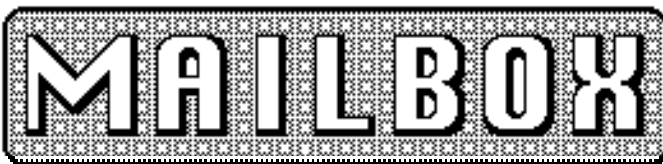

LARGE FLOATING STRUCTURES ON JUPITER

The large floating cities envisioned by Kokh in the concluding chapter of the Xities series indeed would be excellent laboratories for the further

exploration and utilization of the gas giant planets such as Jupiter, Saturn, and Uranus using technology one century of human progress more advanced than ours. These types of planets contain elements in solar abundance needed to perform the most difficult of all space missions, i.e., construct and power star ships of the type envisioned by John MacVey in *Journey to Alpha Centauri*, which attain a small percentage of the speed of light using enormous fusion power.

In addition, large gas giants are foreseeably the only planets we will easily be able to detect around other star systems, using infrared excess, radial velocity variation, or perturbation methods, from Earth-based or Earth-orbiting telescopes. Hence the technology to utilize them as bases, or as resource gathering centers for restocking preparatory to another interstellar voyage is important, whether by "generation travel" human colonies or long-lived AI [artificial intelligence] machine systems.

Aerostat Xities in the pre-interstellar age would likely be useful as bases conducting technological experiments in resource utilization of the gas giant planets, possibly then preparatory to the development of interstellar systems.

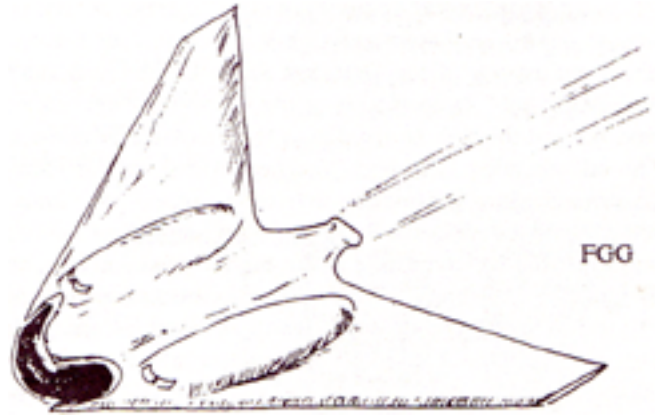

Twenty years ago I too suggested large floating structures in the atmosphere of Jupiter, driven by ice-water cycle engines. The floating bases could be connected by a transportation net of "inverse jets", i.e. aircraft with an oxygen supply and intakes for hydrogen. It was at Bruce Hapke's Planetary Physics class in 1978 that I first made this suggestion publicly. On Jupiter, the oxygen would be freed from atmospheric compounds such as water vapor, by dissociation.

Francis G. Graham
East Pittsburgh, PA 15112

[Francis Graham is Editor of *Selenology*, the quarterly of the American Lunar Society of which he has been a past president. He has an association with the Allegheny Observatory in Pittsburgh, and teaches at Kent State U. in East Liverpool, Ohio. An SSI Senior Associate, he has done Earth-based observations for sodium vapor over the Lunar poles leading to a pessimistic conclusion about the chances of appreciable caches of water ice there.]

[The following two letters in response to the above material were printed in MMM #62, and as germane, are also printed in this volume of MMM Classics.]

Reflections on the Xities Series

As a new reader, I have several thoughts in response to your series on Xities. [snip first part]

The Lessons from Biosphere 2

5. A most pregnant experiment in life support systems is Biosphere 2. I had formed an impression that the place leaked air as if it were drafty. I find instead that it leaks only 2% as much as the Shuttle spacecraft; and that change in the mix of atmospheric gas has been a most useful item to track for this first year. I believe that "man in a can" can't make it for very long or very far, out there. Several thousand other living species will have to go along for the ride, and incidentally to furnish the food, scrub the air, provide occupation and learning, and staff the recycle center. Biosphere 2 started with 3,800 logged species, and doubtless some stow-aways of unknown capability. "Out there" it may take 50,000 species and a few pixies. Do we acknowledge that farming and fishing are still the most fundamental occupations of humanity anywhere, and that our other great industries and institutions all depend on the folks with the hoes or their tractors, using energy (solar or mined) to raise our groceries? Asteroidal, Lunar, Space Station, and Vehicular Gardening will be major challenges, but I question the assumption that humanity can make it as one species alone, outside [Earth], on a sustainable basis. Who ever stocked a multi-generation pantry?

Laotian C. Faust
Oak Ridge, TN

=====

Aerostat Xities: Corrections to "Lift" Values

I enjoyed your series on Xities and the look further out. A few words about lifting gasses. The figure of merit that you chose, ratio of molecular weights of atmospheres to lifting gasses, may be misleading. At a particular design condition (say, one bar pressure), the important number is the difference in weights. A unit volume of Earth's air might weigh 29 units, while the same volume of helium weighs 4 units, and the lift is (29-4) = 25 units. For hydrogen the lift is (29-2) = 27 units, only 8% more whereas a quick look at your chart implies a 100% improvement by using H₂. As a thought experiment, imagine that there was a totally weightless gas. By your figures the lift would be 29/0 = infinite! - Here's your chart, reworked to show differences in mole weight.

Earth H2	Earth He	Titan H2	Uranus H2	Venus H2	Venus CO	Venus Air
27	25	26	0.3	42	16	15
0.93	1	0.96	830*	0.60	1.56	1.67

Volume of the gas bag needed compared to that of a helium balloon on Earth, same payload

[* ED.: e.g. with radius 9 times, and length 10 times as large.]

As you can see, Venus looks quite friendly to airship designers, thanks to its heavy air, while the gas giants seem terribly hostile. On Venus, the habitat's air can provide nearly the lift of CO [so that they could live in the gas bag!].

There are tricks which can be used to improve on these numbers, and on Uranus the designer needs all the help he can get. One trick is to lower the operating altitude. At 10 bar, the buoyancy of a given volume is ten times as great. On Venus and the gas giants this is a possibility. The other trick is to heat the lifting gas, as hot air balloons do. At the colder upper atmosphere altitudes in most planets, 30-50°C [86-122 F] of warming helps big time. The heating can come from power plant waste heat, solar, or microwave sources. Aerostats scale up nicely, thanks to the square/cube relationship of surface area/enclosed volume, so at 90 km above Venus, you might have solar geodesic domes that are miles across.

A Late 70s Uranus aerostat design exercise

Back in the heyday of the Preposterous Systems Design Group [Chicago Society for Space Settlements], we did a number of takeoffs from the BIS [British Interplanetary Society] Project Daedalus' He3 processing balloon. A move from Jupiter to Uranus seemed in order, and we decided a dirigible would be preferable to a free floating balloon, even though a streamlined gas bag would weigh more and the airship's motion would increase the cooling of the lifting gas. Mobility would be useful on several counts: (1) avoiding storms, if any; (2) staying near the equator, because Uranus' rotation could provide several times the head start to departing space-craft that Kourou gives to Ariane. The banded nature of the gas giants makes this fairly easy at the right altitudes, but in the late 70's we didn't know which altitudes would be helpful. (3) leaving the He3-depleted exhaust behind, preventing re-ingestion; (4) making it easier for arriving planes to dock.

The model U-1 airship had an extendible arresting system somewhat like an aircraft carrier's. it was a straightforward blimp whose propulsion was provided by the processing plant's enormous mass flow. The U-1B was similar, but the aft end of the gas bag was wider to improve its efficiency as a lifting body. Model U-2 was much larger, with a lens shaped, cable-reinforced gas bag attached to a circumferential compression ring. Tail surfaces allowed it to operate as an enormous flying wing. We played with slower moving designs of this sort: the U-2A blew the exhaust outward over the upper surface of the hull, producing lift by Coanda effect, and the U-2B had wings extending radially. As the airship revolve, merry-go-round style, it became a helicopter. Because of the rigid airframe, it seemed possible to deploy the U-2 from orbit, in a somewhat stripped down state. With a disposable heat shield, the atmospheric entry vehicle would have a reasonable L/D ratio & low wing loading.

Joe Suszynski, Chicago, Illinois



Watch for the next two volumes of MMM Classics, MMMC # 7 and MMMC #8, in January, 2006